

PenCentra 200

Handheld PC Pro
User's Guide

FUJITSU

Fujitsu PC Corporation has made every effort to ensure the accuracy and completeness of this document; however, because ongoing development efforts are made to continually improve the capabilities of our products, we cannot guarantee the accuracy of the contents of this document. We disclaim liability for errors, omissions, or future changes herein.

Fujitsu® is a registered trademark of Fujitsu, Ltd.

PenCentra™ 200 and Working Mobility™ are trademarks of Fujitsu PC Corporation

CalliGrapher® and ParaGraph® are registered trademarks of ParaGraph, a division of VADEM.

Jot® and Handwriter® are registered trademarks of Communication Intelligence Corporation.

ActiveSync™, ActiveX®, Microsoft®, Microsoft InkWriter®, Microsoft Outlook™, Microsoft PowerPoint®, Microsoft Windows®, Microsoft Windows NT®, MSN™, Visual Basic®, Visual C++®, and the Windows logo are either registered trademarks or trademarks of Microsoft Corporation in the United States and/or other countries. Microsoft products are licensed to OEMs by Microsoft Licensing, Inc., a wholly owned subsidiary of Microsoft Corporation.

Insignia® is a registered trademark and Jeode™ is a trademark of Insignia Solutions.

All other products are trademarks or registered trademarks of their respective companies.

Copyright 2001
Fujitsu PC Corporation

No part of this publication may be copied, reproduced, or translated, without the prior written consent of Fujitsu PC Corporation. No part of this publication may be stored or transmitted in any electronic form without the prior consent of Fujitsu PC Corporation.

PenCentra 200 User's Guide - FPC58-0545-01

Agency Compliance

UL Notices

WARNING

- For continued protection against the risk of fire, replace only with the same type and rating of fuse.

CAUTIONS

- Changes or modifications not expressly approved by Fujitsu PC Corporation could void this user's authority to operate the equipment.
- For a spare battery pack, order only Fujitsu Model FMW51BP1.
- To charge the battery pack FMW51BP1 externally, use only a PenCentra external battery charger FMW51BC1.

NOTE

This product is intended to be supplied by a Listed Power Unit marked "Class 2" and rated 16 Vdc, 2.7A to 3.36A.



Output Polarity



**DECLARATION OF CONFORMITY
according to FCC Part 15**

Responsible Party Name: **Fujitsu PC Corporation**
Address: **5200 Patrick Henry Drive**
Santa Clara, CA 95054
Telephone: **408-982-9500**

Declares that product: **Model: PenCentra 200**
Complies with Part 15 of the FCC Rules

This device complies with Part 15 of the FCC rules. Operation is subject to the following two conditions: (1) This device may not cause harmful interference, and (2) This device must accept any interference received, including interference that may cause undesired operation.

Note: *For more detailed information about the FCC rules and their applicability to the PenCentra 200 pen tablet, refer to Appendix D of this document. The following table provides the part numbers for each of the PenCentra 200 configurations.*

Table of Contents

Before You Get Started	vii
Welcome.....	vii
About this Guide.....	vii
Where to Find Information.....	ix
Chapter 1	
Introducing the PenCentra 200 H/PC Pro	1
Included with the PenCentra 200	1
.....	1
Options Available for the PenCentra 200.....	2
PenCentra 200 Hardware Features.....	3
Front / Left / Top Features.....	3
Rear / Right / Bottom Features.....	5
Status Indicators.....	7
Connectors and Peripheral Interfaces	8
PenCentra 200 Software	10
Windows CE Applications	10
Common Applications	10
Windows CE 2.11 Applications	11
Microsoft H/PC 2000 Applications.....	12
Handwriting Recognition Applications	12
Windows CE 2.11 Systems.....	12
Microsoft H/PC 2000 Systems	12
Chapter 2	
Using the PenCentra 200	15
Before Setting Up the PenCentra 200	15
Setting Up the PenCentra 200	15
Turning the device off and on (suspending/resuming)	15
Resetting the system	16
Using the Pen.....	17
Calibrating the pen	17
Replacing the Pen.....	18
Inserting/Removing PC Cards.....	19
Powering the PenCentra 200	20
Removing and Installing a Battery Pack	20
Charging the Battery Pack.....	21
Conserving Power / Optimizing Power Management.....	21
Using a Keyboard or Mouse with the PenCentra 200	21
Attaching a Keyboard or Mouse.....	22
Using the Keyboard Function Keys	22
Using the Hotpads.....	23

Chapter 3

Using Microsoft CE Applications	25
Windows CE Applications	25
Microsoft Pocket Office	25
Pocket Word: Creating Documents.....	26
Taking notes using Pocket Word.....	27
Pocket Excel: Creating Workbooks	28
To log expenses using Pocket Excel:	28
Pocket Access: Viewing and Creating Data	30
To create a new database and table on your PenCentra 200:	31
Pocket PowerPoint: Showing Presentations	32
To show a presentation:	32
Voice Recorder and InkWriter	34
Voice Recorder: Capturing Ideas and Thoughts	34
InkWriter: Creating Notes and Drawings.....	36
To create an InkWriter document:.....	36
Microsoft Pocket Outlook	37
Calendar: Scheduling Meetings and Appointments.....	38
To create a new appointment:.....	39
To create a meeting request:.....	40
Contacts: Tracking Friends and Colleagues.....	41
To create a new contact:	41
Tasks: Keeping a To Do List	42
To create a new task:	43
Inbox: Sending and Receiving E-mail Messages	44
Connecting to a mail server.....	45
Setting up Inbox for connecting to a mail server	45
Downloading messages	46
Disconnecting from the server	46
Managing messages and folders.....	46
ActiveSync: Synchronizing E-mail	48
Downloading messages	48
Managing messages and folders.....	49
Sending a message	49
To send a message:	49
Getting Connected Remotely	50
Connecting to an ISP	51
To create a dial-up connection to an ISP:	51
Connecting to Your Network.....	52
To create a dial-up connection to a network:.....	52
To create a network (Ethernet) connection:	52
Connecting to Your Desktop to Synchronize Remotely.....	53
To create a dial-up connection to a desktop modem.....	55
Getting Help on Connecting Remotely.....	55
Microsoft Windows CE Services.....	56

Installing Windows CE Services and Setting up a Partnership	56
Synchronizing Files and File Conversion	57
Remote Synchronization	58
Getting Help on Windows CE Services	58

Chapter 4

Using the Handwriting Recognition Utilities	59
What is CalliGrapher?	59
Getting started	60
The Two Icons Explained	61
Basic writing and corrections	63
What is displayed in the Correction Window?	67
Gestures and spell checking	67
Text Editing Using CalliGrapher	72
How to Select Text Using Pen (Stylus)	80
Screen Drawing	80
Screen Orientation	82
Calculator	82
Configuration Tips.....	83
Multiple User Dictionaries	83
Taskbar Customization	83
More Pleasant vs. More Detailed Inking	84
If You Aren't a Cursive Writer.....	84
Quick Note Taking.....	84
Fine-tuning the Handwriting Features	85
Using Handwriter for HPC 2000	87
General tab	87
Appearance tab	87
Time-Outs tab	88
Advanced tab.....	88
About tab.....	88

Chapter 5

Care and Maintenance of the PenCentra 200	89
Protecting the Display Screen	89
Installing a Screen Protector	89
Storing the PenCentra 200	90
Protecting the PenCentra 200 Pen Tablet in Harsh Environments	91
Avoiding Overheating	91
Cleaning the Display Screen.....	91

Chapter 6

Troubleshooting the PenCentra 200	93
System Will Not Resume Operation	93
Display Screen Is Blank or Difficult to Read.....	93

Infrared Data Transfer Is Not Working	94
Pen Tablet Is Not Responding to the Pen.....	94
Pen Tablet is Not Responding to the Keyboard	94
Pen Not Calibrated	95
Audio Volume Too Low	95
Remote connection problems.....	95
Can't dial out with the device modem	95
Can dial out but can't make a proper connection	96
The connection is unreliable.....	96
Network connection is not listed in the ActiveSync dialog box	96
PenCentra 200 H/PC Pro Hardware Specifications	97
Digitizer Technology Notice	101
Additional Display Information	101
Glossary	103
Agency Notices	109
FCC Notices	109
Notice to Users of Radios and Television.....	109
Notice to Users of the US Telephone Network.....	109
DOC (Industry Canada) Compliance Notices	111
Notice to Users of Radios and Television.....	111
Notice to Users of the Canadian Telephone Network.....	111
Avis Aux Utilisateurs Du Réseau Téléphonique Canadien.....	112

Before You Get Started

Welcome

Congratulations on purchasing a PenCentra 200 Handheld Personal Computer Pro (H/PC Pro) powered by the Microsoft® Windows® CE operating system. This enterprise-level pen computer provides a rugged ergonomic design, high performance, and minimal weight. The PenCentra 200 delivers Working Mobility™ by putting the power of information in the palm of your hand.

About this Guide

This guide provides an introduction to your PenCentra 200, the Microsoft Windows CE operating system, and the installed applications. The following chapters are contained in this document:

Chapter 1: Introducing the PenCentra 200

This chapter introduces you to the features of your PenCentra 200. Included are descriptions of the material included with your system and optional peripherals specially designed for the PenCentra 200.

Chapter 2: Using the PenCentra 200

This chapter provides steps for the initial setup of your system, as well as a brief description of the software loaded on the system. Also included are instructions for a variety of procedures, such as printing and customizing your PenCentra 200.

Chapter 3: Using Microsoft CE Applications

This chapter offers details on the various Windows CE applications, such as Pocket Word, Pocket Access, and Pocket Excel. Included are instructions for setting up the Windows CE Services software on your desktop or laptop computer to allow synchronization of data between the PenCentra 200 and your desktop or laptop.

Chapter 4: Using the Handwriting Recognition Utilities

This chapter provides instructions on using the CalliGrapher® programs from ParaGraph™. The program delivers highly-efficient, easy-to-use applications.

Chapter 5: Care and Maintenance of the PenCentra 200

This chapter instructs you in the proper care and maintenance of your system.

Chapter 6: Troubleshooting the PenCentra 200

This chapter offers troubleshooting tips and techniques in the event you run into a problem when operating your pen tablet.

Appendix A: Hardware Specifications

This appendix contains detailed information about your PenCentra 200 specifications.

Appendix B: Digitizer Notice

This appendix contains notices concerning the formation of air bubbles in the digitizer.

Appendix C: Glossary

The Glossary contains a description of Microsoft and Fujitsu PC Corporation terms used throughout this guide.

Appendix D: Agency Notices

This appendix contains notices required by the Federal Communications Commission.

Where to Find Information

This guide describes your PenCentra 200 hardware, provides an overview of the programs included, and describes how to set up communications between your PenCentra 200, your desktop computer, and the Internet. The following table is a guide to the different types of information available to help you use your PenCentra 200. For more information, see the comprehensive on-line Help for each program.

For Information On...	Use This Reference...
PenCentra 200 H/PC Pro Hardware	This User's Guide
	Fujitsu PC Corporation web site: http://www.fujitsupc.com/
Windows CE Programs	This User's Guide
	On-line Help on your device. Select Start and then Help for each program.
ParaGraph CalliGrapher 5.3.6	This User's Guide
	On-line Help on your device. Select CalliGrapher Help from the Programs CalliGrapher menu.
	CalliGrapher web site: www.paragraph.com
Jot and Handwriter for HPC 2000	CIC web site: www.cic.com
Insignia Jeode	Insignia Jeode web site: http://www.insignia.com/
Synchronizing and exchanging files with a desktop computer (including information on connecting while traveling)	This User's Guide
	On-line Help on your device. Select Start and then Help .
	Windows CE Services on-line Help on your desktop computer. In the Mobile Devices window, click Help , then Windows CE Services Help Topics . For additional information, go to www.microsoft.com/windowsce .
Toolbar buttons	Tap or click and hold on a toolbar button to see its name. Drag off the toolbar button before lifting to avoid activating the button.

For Information On...	Use This Reference...
Troubleshooting information on connections	The Communications Troubleshooter on your desktop computer. In the Mobile Devices window, click Help , then Communications Troubleshooter .
Up-to-date information on Windows CE-based devices	Microsoft Windows CE web site: http://www.microsoft.com/windowsce/ Microsoft Handheld PC site: http://www.microsoft.com/mobile/handheldpc/
Information on this release of Windows CE	Readme.doc file (located in the Windows CE Services folder on your desktop computer).

Chapter 1

Introducing the PenCentra 200 H/PC Pro

The PenCentra 200 is a high-performance, pen-based computer designed to support the Microsoft Windows CE operating system. This chapter provides an overview of the PenCentra and its features.

Included with the PenCentra 200

The following items are included with your PenCentra 200:

- Lithium ion battery pack
- AC Adapter
- Microsoft Windows CE Services CD-ROM
- Screen Protectors (quantity: 2)
- PenCentra 200 Pen
- Internal 56 Kbps* fax/modem (V.90)

* Actual speeds over U.S. telephone lines vary, and are less than 56Kbps due to the current FCC regulations and line conditions.

The internal modems on all Fujitsu pen tablets from Fujitsu PC Corporation are only qualified for use with telephone systems in selected countries, including the United States and Canada. For a full list of certified countries, check www.fujitsupc.com/modems.

Options Available for the PenCentra 200

The following optional peripherals and accessories items are available to support your PenCentra 200:

- Auto Adapter (FMWCB2)
- Spare Pen (FMW51PN1)
- Pen Tether (FMW51ST1)
- Docking Station (FMW51DS1)
- 16MB RAM Expansion Module (FMW51EM16)
- 32MB RAM Expansion Module (FMW51EM32)
- Harsh Environment Case (FMWCC36)
- Spare Battery Pack (FMW51BP1)
- External Battery Charger (FMW51BC1)
- Handstrap (FMWHS3)
- Screen Protectors, 12-pack (FMWSP6)
- Compact Folding Deskstand (FMWDS4)
- System Holster (FMWCC34)
- Harsh Environment Case Holster (FMWCC37)
- Slipcase (FMWCC33)
- Portfolio Case (FMWCC35)
- USB Keyboard:
 - US (FMWKB5A)
 - UK (FMWKB5B)
 - France (FMWKB5F)
 - Germany (FMWKB5D)

PenCentra 200 Hardware Features

Features and controls that you use to operate the PenCentra 200 are described below and illustrated in Figures 1-1 and 1-2. Additional details on using these features and controls are provided later in this manual.

Front / Left / Top Features

- **Screen**
The screen is the area in which your applications and data are displayed. The screen is also the area in which you enter data with the pen.
 - **Status Indicators**
There are three status indicators that provide event notification and power status.
 - **Pen/Pen Holder**
The pen -- or *stylus* -- is the main pointing device used for navigation and entering data. When not in use, it should be stored in the PenCentra 200 pen holder or optional carrying case.
 - **Record Button**
The Record button is used to initiate recording of sound on the system via the microphone.
 - **Microphone**
The microphone allows you to record sound files, such as voice memos.
 - **Hotpads**
Hotpads allow you to change settings for the display, sound, and mouse button emulation. Three programmable hotpads are also available for customization.
 - **IrDA Port**
Provides an infrared interface for communication with devices compliant with IrDA Standard Revision 1.1.
 - **Suspend/Resume Button**
Allows you to suspend and resume system operation in order to extend battery life.
 - **Modem Jack***
Allows you to connect a standard telephone plug to the PenCentra's internal 56 Kbps modem.
- ** The internal modems on all Fujitsu pen tablets from Fujitsu PC Corporation are only qualified for use with telephone systems in selected countries, including the United States and Canada. For a full list of certified countries, check www.fujitsupc.com/modems.

- **Reset Button**
The Reset button restarts the PenCentra 200.
- **PC Card Slots**
These doors allow you to access the PC Cards installed in the PC Card slots.
- **Kensington™ Lock Attachment Point**
The lock attachment point lets you attach an optional Kensington-type security cable.
- **Notification Button**
The Notification button is used to acknowledge a notification from the system, such as a meeting reminder.

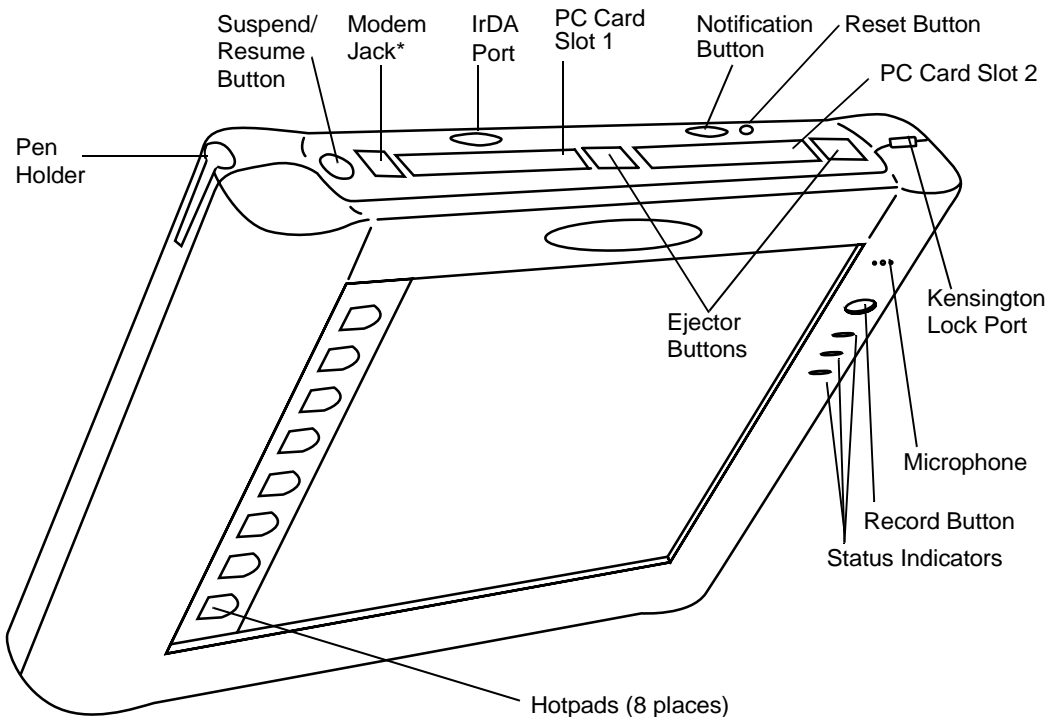

Figure 1-1 PenCentra Front/Left/Top View

** The internal modems on all Fujitsu pen tablets from Fujitsu PC Corporation are only qualified for use with telephone systems in selected countries, including the United States and Canada. For a full list of certified countries, check www.fujitsupc.com/modems.

Rear / Right / Bottom Features:

- **Removable Battery Pack**
The battery pack can be removed for replacement or charging in an optional external charger.
- **Battery Pack Latch**
Secures the removable battery in position.
- **Pen Tether Attachment Slot**
The pen tether slots allow you to attach an optional pen tether.
- **Handstrap Attachment Points**
These are used to attach an optional handstrap.
- **Speaker**
The built-in speaker allows you to play back audio files without external hardware.
- **Memory Access Door**
Allows you to gain access to the RAM, ROM, and flash memory modules inside your PenCentra.
- **Microphone Jack**
Allows you to connect an external microphone
- **Headphone Jack**
Allows you to connect headphones to your PenCentra 200.
- **Serial Port**
This port is used for connecting the synchronization cable between your PenCentra 200 and a desktop computer. This port can also be used as a standard serial port.
- **USB Port**
Allows you to connect Universal Serial Bus-compliant devices to the PenCentra 200.
- **DC Input**
Allows you to connect the AC Adapter or an optional Auto Adapter.
- **PS/2-Style Keyboard/Mouse Port**
The PS/2-style port lets you attach a PS/2-style keyboard or mouse. This port only supports a 5V keyboard or mouse.
- **High-Usage Docking Contacts**
These contacts allow you to use the pen tablet in an optional docking station.

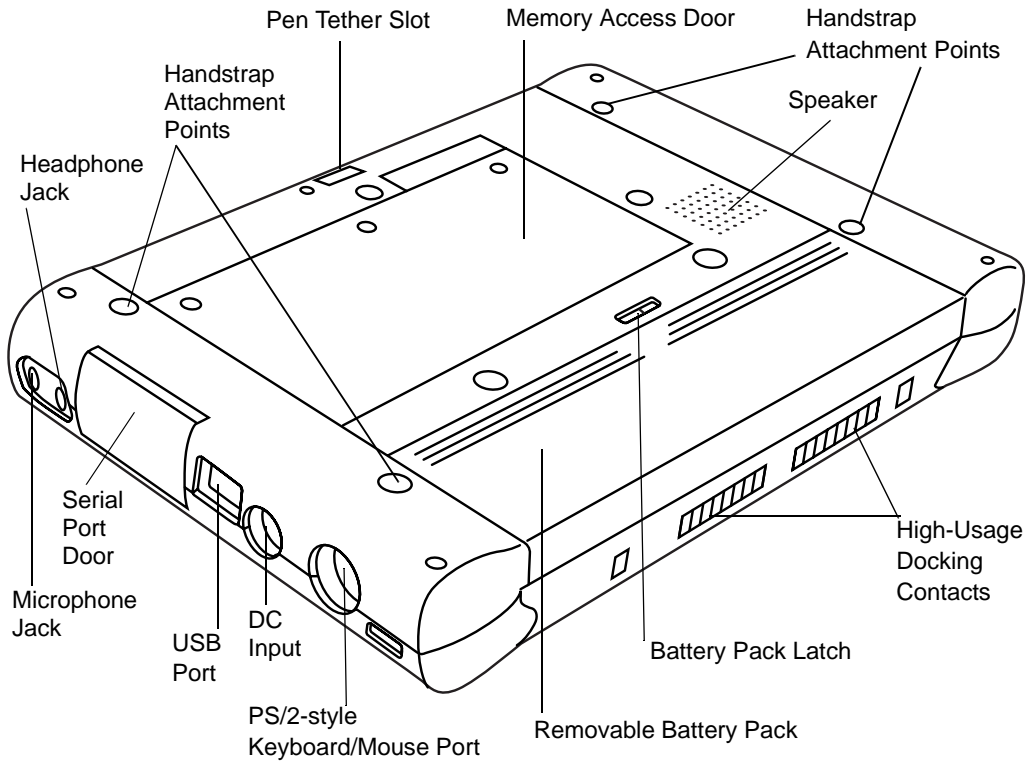





Figure 1-2 PenCentra Rear/Right/Bottom View

Status Indicators

There are three status indicators located on the front of the system, adjacent to the right-hand side of the screen. These lights indicate the information about system status:

Table 1-1 System Status Indicators

Display Icon	Name	LED State (Significance)	Description
	Notification Indicator	Orange (Notification of event)	The notification indicator flashes when a pre-determined event is detected by the system (such as a meeting reminder). The notification indicator is reset by pressing the notification button on the top of the system.
	DC Input	Off (No battery, no DC Input) Orange (Charging) Green (Charge complete) Yellow (Thermal Alarm)	When this indicator is lit, the system is running on external DC power.
	Battery	Off (Battery is between 20% and 100% charged) Orange, blink (every 2-4 seconds) (Between 5% and 20%) Orange, no blink (Between 0% and 5%)	This LED indicates low battery conditions.

Connectors and Peripheral Interfaces

The connectors and peripheral interfaces on the PenCentra 200 can accommodate a variety of different devices. Figures 1-1 and 1-2 show the locations of the connectors and interfaces on the PenCentra 200, as described in Table 1-2.

Table 1-2 Peripheral Connectors







Connector/ Peripheral	PenCentra 200 Icons	Purpose
Microphone Jack		Connect an external microphone. The internal microphone is disabled when you plug in an external microphone.
Record Button		Initiates the recording of audio files (such as voice memos) on the PenCentra.
Notification Button		The notification button is used to turn off the notification indicator, and launch the message that generated the notification.
Kensington Lock		The Kensington™ Microsaver security slot allows you to secure the PenCentra using Kensington-compatible locking devices.
PC Cards		Install one or two Type II PCMCIA Cards. If only one card is installed, either slot can be used.
IrDA Port		The infrared transceiver built into the PenCentra allows you to communicate with other devices that are compliant with IrDA Standard Revision 1.0 or 1.1. Effective range for infrared communication is about three feet, and within 15 degrees off of center. A clear line-of-sight path must exist between the IrDA port on the PenCentra and the IrDA transceiver on the other device.

Table 1-2 Peripheral Connectors (Continued)











Connector/ Peripheral	PenCentra 200 Icons	Purpose
Modem Jack		Connect a telephone line to the internal international software modem using a standard RJ-11 telephone plug. The modem is only certified on North American, French, German, and United Kingdom models of the PenCentra 200.
Suspend/ Resume Button		Allows you to suspend and resume system operation.
High-Usage Contacts		Used when the PenCentra is installed in an approved optional docking device. The contacts allow system access via PS/2 keyboard, USB-Host, RS-232C serial input, and DC input.
PS/2-Style Port		Allows the connection of a 5-volt PS/2-style keyboard, mouse, or barcode reader. Note that the system must be suspended prior to installing a device to this port.
DC Input		Connect an external power source such as the AC Adapter or the optional Auto Adapter.
USB Port		Connect Universal Serial Bus-compliant devices
Headphone Jack		Connect mono headphones or powered external speakers. The internal speaker is disabled when you plug in external headphones or speakers.
Serial Port		Connect an external device with a serial interface. Primarily used to connect the synchronization cable between the PenCentra 200 and your desktop system. (Note that this icon appears on the inside of the serial port door). Pin 9 of the serial port supports 5-volt, 500 mA maximum current.

Table 1-2 Peripheral Connectors (Continued)

Connector/ Peripheral	PenCentra 200 Icons	Purpose
Battery Latch		This spring-loaded latch/switch secures the removable battery in its slot.
Speaker		Allows you to hear audio files.

PenCentra 200 Software

The PenCentra 200 contains a number of Microsoft Windows CE and third-party applications. A summarized description of each is provided below. Detailed information about these programs is located in Chapter 3 of this manual.

Windows CE Applications

The PenCentra 200 is a Microsoft Windows CE H/PC 3.0 Pro-compliant system. Windows CE consists of two general elements: the Microsoft Windows CE operating system and Windows CE Services with ActiveSync. A suite of applications called Microsoft Windows CE Pocket Office is also included with Windows CE.

Note: *The PenCentra 200 system is delivered with one of two software configurations: Windows CE 2.11 or Microsoft Windows CE H/PC 2000. Many of the software applications used by the two configurations are the same. The applications are listed below as either common or exclusive to one of the configurations.*

Common Applications

1. **Windows CE Operating System.** The operating system installed on your PenCentra 200.
2. **Microsoft Windows CE Pocket Office**, consisting of:
 - **Microsoft Pocket Access**
View ODBC databases and create Access information.

- **Microsoft Pocket Excel**
Create and view Excel documents.
- **Microsoft Pocket PowerPoint**
Allows you to present PowerPoint presentations.
- **Microsoft Pocket Word**
Lets you create and view Word documents.
- **Microsoft Pocket Outlook**
Pocket Outlook consists of the Calendar, Contacts, Tasks, and Inbox applications. These help you to manage your day-to-day information, including appointments, email, and personal data.
- **Microsoft Pocket Internet Explorer**
Allows you to set up connections with other computers or the Internet.
- **Microsoft InkWriter**
Lets you create handwritten or typed notes and drawings.
- **Microsoft Voice Recorder**
Records your spoken words.
- **World Clock**
Sets the date, time, and alarm for your home city and the city you are visiting.
- **Calculator**
Lets you perform calculations
- **Microsoft Windows CE Services with ActiveSync** is included on CD-ROM for installation on your desktop system. Windows CE Services allows you to synchronize your data between the PenCentra 200 and your desktop.

Windows CE 2.11 Applications

- **PC Link**
Initiates a connection with your desktop computer.
- **Terminal**
Lets you view and download files from a bulletin board or send and receive E-mail.
- **Insignia Jeode** software is included to securely load and run Java applications and applets on your system.

Microsoft H/PC 2000 Applications

- **Terminal Server Client**

Allows you to log on to a Windows NT server that has Terminal Server software installed and to use all the programs on the NT system.

- **Application Launcher**

Allows you to determine which applications are launched with the system hotpads.

Handwriting Recognition Applications

Windows CE 2.11 Systems

Along with the Microsoft Windows® CE applications, FPC has included the ParaGraph™ CalliGrapher® application. CalliGrapher is a full-featured technology that recognizes all handwriting styles: cursive, print, or mixed. The following list lists some of the features of the CalliGrapher program:

- Optimized to work with color Windows CE-based device.
- Reliably recognizes cursive, printed, and mixed handwriting from a wide range of handwriting styles
- Integrates with all Windows CE applications
- Includes vocabulary checker and spell-checker with a user dictionary
- On-screen pop-up keyboard

Microsoft H/PC 2000 Systems

The H/PC 2000 systems include two handwriting recognizers from Communication Intelligence Corporation: Jot and Handwriter for HPC 2000. Jot offers single character recognition, providing immediate user feedback. Handwriter provides full context natural character recognition with complete macro and gesture support. The following list describes some of the features of the program:

- Data input is more natural. No special symbols or characters to memorize. Jot allows users to input text by using standard upper and lower case printed letters that offer ready-to-go recognition of printed characters without requiring any training.
- Full-Screen Support. Jot enables users to input text on the full screen or in the input panel area. Jot supports writing in place so that you can write one letter on top of another and never run out of screen space.

- **Simple User-Interface.** Jot uses mode marks to divide the input area into different regions so where you write determines if the character will be read as upper case, lower case, numeric or a symbol. Jot enables you to use the center area of the screen to get capital letters.
- **See Your Writing in Ink.** Jot helps users improve their recognition accuracy by enabling characters to be viewed in ink as they are written.
- **International Character Support.** Jot supports recognition of Roman-based Western European languages and accent marks.
- **Tutorial.** Jot provides an extensive tutorial demonstrating how to write letters and symbols.
- **Macro Editor:** You can define frequently used phrases (such as name and E-mail address) or actions (such as copy or paste) for quicker text entry and editing.

Chapter 2

Using the PenCentra 200

This chapter covers the fundamental concepts, basic system operation and use, and system functions of your PenCentra 200. You should familiarize yourself with this information before you attempt to operate the system.

Before Setting Up the PenCentra 200

Before you set up your PenCentra 200, there are two very important steps to perform:

- The display screen can be damaged with improper use. Be sure to **install one of the included screen protectors on your system**. Reference the installation instructions that accompany the screen protector.
- **The system should be charged for a full 48 hours** prior to first using it. The 48-hour period ensures that the main battery pack and the backup battery are fully charged.

Setting Up the PenCentra 200

Turning the device off and on (suspending/resuming)

The suspend/resume button is used to stop and start the operation of your PenCentra 200. Suspending system operation with this button does not shut the system down, it simply “puts it to sleep” until you’re ready to use it.

To resume system operation, press the suspend/resume button on the top of the system (see Figure 2-1). When you press the button, the system immediately “wakes up” and resumes at the same point as when you suspended operation.

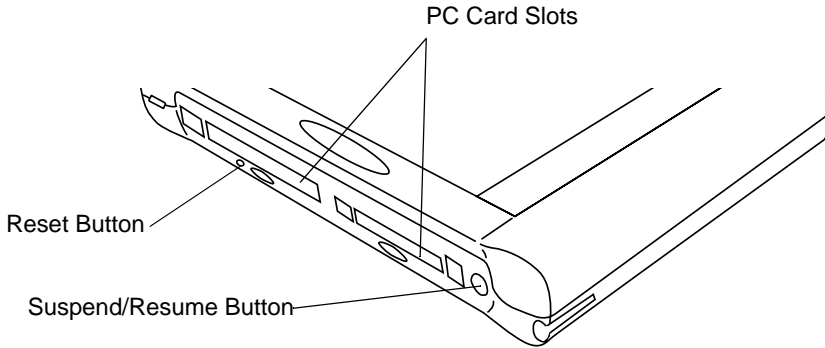

Figure 2-1 Location of Suspend/Resume Button

When you have finished working with your PenCentra, or when you will not be using it for an extended period, you should suspend operation to conserve battery power. There are two ways to suspend the system:

Note: *It is good practice to **always** save your active data before suspending the system. Doing so ensures that no data is lost in the event of power interruption.*

- Save your work, then press the suspend/resume button. The system operation will immediately suspend. When you resume operation, the system will resume at the point at which you suspended operation, or,
- Save your work, then click the Start icon on your desktop. Click on Suspend from the Start menu. The system operation will immediately suspend. When you resume operation, the system will resume at the point at which you suspended operation.

Resetting the system

- Note:**
- *Pressing the reset button while there is active data on your screen will result in that data being lost.*
 - *It is not necessary to use excessive pressure when depressing the reset button. Excessive pressure could result in damage to the system.*

In the event your system freezes up and does not respond to pen taps or keystrokes, it may become necessary to reset the system. To reset the system, lightly press the reset button (see Figure 2-1) using the tip of your PenCentra pen. When the reset button is pressed, the system reboots.

Using the Pen

You can use the PenCentra pen to generate and capture electronic “ink”, to select items, and to navigate through programs on the pen tablet. The pen can be used like a two button mouse when used in conjunction with the right-mouse button hotpad. Programs that support handwriting recognition allow you to write characters directly on the screen with the pen.

Caution

- Ensure that a screen protector is installed on the pen tablet screen before you use the pen. The warranty does not cover a screen that is scratched as a result of not using a screen protector.
- Do not use a ballpoint pen or any sharp object on the pen tablet. Doing so can mar or scratch the screen surface.

Here are some hints on using the pen like a two-button mouse on a desktop system:

- **To select an object**, tap the mouse tip on the object once. This functions like a mouse button click with the left mouse button.
- **To “double-click” an object**, tap twice on the object quickly.
- **To “right-click”**, tap the pen tip once on the right-mouse button hotpad, then tap the desired object. (Hotpads are described in the section of this chapter entitled “Using the Hotpads”). The right mouse function is only valid for a single tap.
- **To move, or “drag”, an object on the screen**, place the pen tip directly over the object, then as you hold the pen tip against the screen, move the pen.

Calibrating the pen

You calibrate the pen to adjust the distance error between where the pen actually touches the screen and where the system “thinks” the pen is touching position on the screen relative to the position of the pen tip. If the event you wish to invoke is not displayed under the pen tip when you use the pen, you should calibrate the pen.

Pen calibration may be required due to the following situations:

- The pen is being used for the first time.
- The previous user of the PenCentra 200 pen tablet writes with the opposite hand or at a different pen angle.

- The system has been in use for some time and the pen has not been recalibrated.
- The system has not been used for a long time and all stored information is lost due to loss of battery power.

To Calibrate the Pen

1. Open the Control Panel from the Start menu, and double-tap the Stylus icon. Select the Calibration property sheet, then click on Recalibrate.
2. Position the PenCentra 200 pen tablet as you normally would during use. Be sure to hold the pen at the angle that you regularly use. Touch the screen only with the pen tip; if you inadvertently touch the screen with your finger or hand during the calibration process, faulty calibration may result.
3. Perform the calibration steps according to the instructions on the screen. The calibration utility displays a cross-hair symbol in the middle and corners of the screen, one corner at a time. Hold the pen as you normally would while using the system and, as accurately as possible, tap the center of each crosshair as it is displayed.

A dialog box is displayed after you tap the last of the four cross-hair symbols. Tap the screen within 30 seconds if you wish to save your new calibration settings. If you don't tap the screen within 30 seconds, the default calibration settings will be used.

4. When the Stylus Properties window reappears, choose one of the following steps.
 - If you are satisfied that you tapped the cross-hairs accurately, tap OK. The taps that you performed in step 3 are then used to calibrate the screen.
 - If you do not want to use the new calibration, tap the cancel box (X).
 - If you want to enter a new calibration, tap Recalibrate. The calibration instructions reappear.

If you have successfully performed the procedure above, the pen is now calibrated, and you can use the system as you normally would.

Replacing the Pen

With use, the pen tip may become worn or may pick up abrasive particles that can scratch the screen. A damaged or warped tip may not move freely, causing unpredictable results when using the pen. If your pen exhibits these problems, replace the pen.

Inserting/Removing PC Cards

There are two PC Card slots in your PenCentra 200 to support Type I or Type II PC Cards. Ensure that the card is PC Card 2.1-compliant and that the proper CE drivers are available to support the card.

With the system display facing you, slot 1 is located on the left and slot 2 is on the right (see Figure 2-2). To install a PC Card, insert it into the selected slot with the label with an arrowhead facing towards the screen. The shutter covering the slot folds into the system as you insert the card. Ensure that the card is properly seated by firmly pushing it in until it stops. When the card is properly seated, the ejector button rises to be flush with the system surface.

To remove a PC Card, first ensure that it is not running. Using the back end of your PenCentra pen, press the ejector button for the card you are removing. When the button is pressed, the PC Card is ejected from the slot. Gently pull the card from the slot.

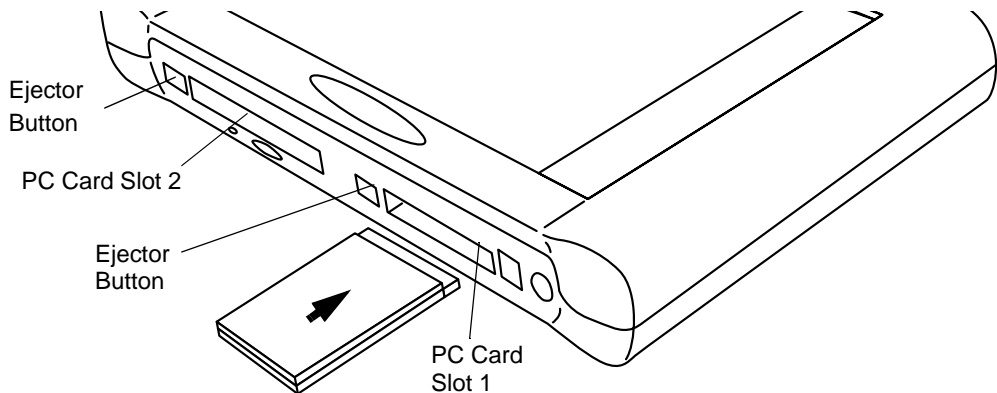

Figure 2-2 Inserting/Removing PC Cards

Powering the PenCentra 200

The PenCentra 200 can be powered by either its rechargeable battery pack or by AC power adapter.

Removing and Installing a Battery Pack

To remove the PenCentra 200 battery pack, perform the following steps:

1. Save any active data and suspend your system.
2. Hold the system face down, with the arrow on the battery compartment pointing towards you (see Figure 2-3).

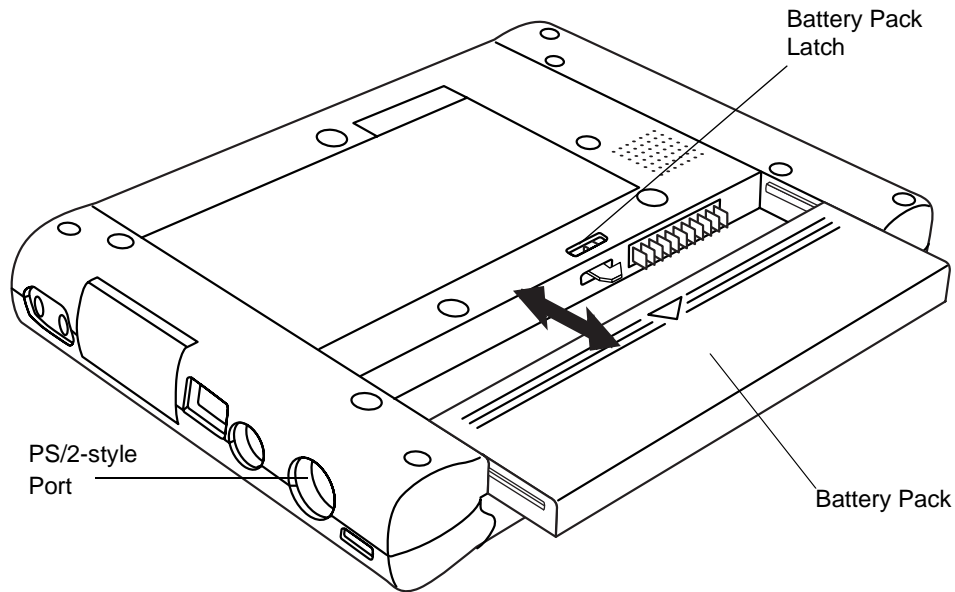

Figure 2-3 Removing/Installing the Battery Pack

3. Using the back end of the system pen (*not* the tip), push the spring-loaded battery latch to the left.
4. While the battery latch is pushed to the left, slide the battery pack out of the battery tray by pulling it towards you. When the battery is clear of the latch mechanism, release the battery latch.
5. Resume system operation.

To install a new or recharged battery pack, slide it into the battery tray and firmly push it in until the latch clicks into place.

Charging the Battery Pack

There are two ways to charge your battery pack: while it is installed in the system or with an optional battery charger (FPC part number FMW51BC1). To use the optional external battery charger, refer to the literature included with the unit.

Note: *An installed battery can be recharged while the system is running or suspended.*

To recharge the battery pack while it is installed in the system, plug the AC adapter into the DC input jack on the right side of the system. Insert the AC adapter's electrical plug into a wall socket. When DC power is connected to the system, the DC Input LED on the front of the system is lit (reference the "Status Indicators" section of Chapter 1 for more information).

Conserving Power / Optimizing Power Management

You can extend the charge life of your battery pack by conserving battery power. A fully charged battery pack can run the system under normal use for approximately 8 hours. Your results may vary, depending upon the applications you use. Here are some suggestions to help you conserve battery power:

Note: *Certain power optimization features may have been disabled by your reseller when the pen tablet was customized.*

- Open the Power Properties screen from the Control Panel. Click on the Power Off tab, and set the length of idle time before you want the system to automatically suspend. The shorter the period, the longer your battery will remain charged.
- Use an external power source such as the AC adapter to power the system whenever possible.
- Reduce the backlight brightness using the backlight brightness hotpad (reference the section of this chapter entitled "Using the Hotpads").
- When you know you won't be using the system for a long period of time, manually suspend the pen tablet by pressing the suspend/resume button.

Using a Keyboard or Mouse with the PenCentra 200

Although the pen, on-screen keyboard, and handwriting recognition applications allow you to enter any type of data into your PenCentra 200, there may be occasions when you prefer to use a mouse or an optional PenCentra 200 keyboard.

Attaching a Keyboard or Mouse

1. Before attaching a keyboard or mouse to your PenCentra 200, suspend system operation by either pressing the suspend/resume button, or clicking on Start/Suspend.
2. Plug the keyboard or mouse plug into the PS/2-style or USB port on the right-hand side of the pen tablet (see Figure 2-3 for the port locations).

Note: *When a mouse is installed, the mouse icon on the control panel appears in the place of the Stylus icon. When a mouse is not installed, the Stylus icon appears. When a mouse is installed, the stylus is still functional.*

3. Resume system operation.

Using the Keyboard Function Keys

When a PenCentra 200 keyboard is attached to your pen tablet, you can use the function keys as shortcut keys to the most commonly-used Windows CE applications. The following table lists the function keys and the application that is invoked when you press the key.

Table 2-1 Default Application Shortcut Keys

Function Key	Application Shortcut
F1	Inbox
F2	Microsoft Internet Explorer
F3	Calendar
F4	Contacts
F5	Tasks
F6	Microsoft Pocket Word
F7	Microsoft Pocket Excel
F8	Microsoft Pocket PowerPoint
F9	Microsoft Pocket Access
F10	Calculator
F11	World Clock
F12	Connecting to Port

Using the Hotpads

The PenCentra 200 hotpads are arranged vertically on the left-hand side of the screen. The following table identifies each hotpad on the PenCentra 200, and offers a description of its use.

Table 2-2 PenCentra 200 Hotpads







Icon	Name	Description
	<p>Backlight Brightness Hotpad</p>	<p>This hotpad changes the LCD backlight brightness by cycling through the following states:</p> <p>Color Reflective LCD (outdoor/indoor display): Low ->Medium ->High ->Off -> Low...</p> <p>Color Transmissive LCD (indoor display): Very Low -> Low -> Medium -> High -> Very Low...</p> <p>The hotpad defaults to whatever level was set when the system was suspended. This hotpad does not repeat if held down.</p>
	<p>Increase Contrast Hotpad</p>	<p>When tapped, LCD contrast becomes lighter by one step. The contrast range is 16 steps.</p> <p>This hotpad repeats if held down.</p>
	<p>Decrease Contrast Hotpad</p>	<p>When tapped, LCD contrast becomes darker by one step. The contrast range is 16 steps.</p> <p>This hotpad repeats if held down.</p>
	<p>Right Mouse Button Hotpad</p>	<p>Tapping this hotpad causes the next pen tap to be interpreted by the system as a right-mouse click. All subsequent taps are interpreted as left-mouse clicks, unless preceded by a tap of this hotpad.</p>
	<p>Volume Hotpad</p>	<p>This hotpad adjusts the volume of the signal fed to the internal speaker and the headphone jack. This hotpad cycles through the following states:</p> <p>High -> Medium -> Low -> Off -> High...</p> <p>This hotpad does not repeat if held down.</p>

Table 2-2 PenCentra 200 Hotpads (Continued)

Icon	Name	Description
	<p>Programmable Hotpads #1, 2, and 3</p>	<p>When one of the programmable hotpads is tapped, it causes an associated application to be launched. If the associated application is already running when the hotpad is pressed, that application is brought to the foreground (a second instance of the application is not started).</p> <p>You can define which application will be launched by configuring the Application Launcher utility located in the Control Panel. Each programmable hotpad can represent up to five different programs.</p> <p>These hotpads do not repeat; pressing them more than once has the same effect as pressing them once.</p>

Chapter 3

Using Microsoft CE Applications

The wide variety of programs delivered with the PenCentra 200 can be divided into three general categories: Windows CE applications, Windows CE Services, and Productivity Package applications. The Windows CE applications and CE Services are covered in this chapter; the handwriting recognition applications are covered in Chapter 4.

***Note:** Some of the applications covered in this chapter may not be applicable, depending upon the customization performed by your reseller or IS department.*

Windows CE Applications

Microsoft Pocket Office

The Microsoft Office companion programs consist of Microsoft Pocket Word, Microsoft Pocket Excel, Microsoft Pocket Access, and Microsoft Pocket PowerPoint. These programs work with the Windows versions of the same programs on your desktop computer to give you easy access to up-to-date copies of your documents.

You can create or edit Excel and Word files, PowerPoint presentation notes, and Access databases and tables on your PenCentra 200. Word and Excel templates are available to help you quickly create documents. Once you have created or edited a document on your PenCentra 200, synchronize it with your desktop computer to copy the new document to your desktop computer. For more information on synchronization, see the section of this chapter entitled “Synchronizing Files and File Conversion”.

To access the Office companion programs, select **Start, Programs, Office**, and then the program you want to open.

***Note:** More information on the procedures described in this chapter, as well as information on additional procedures, can be found in on-line Help on your PenCentra 200. Select **Start, Help**, and then the program on which you want information. Because Windows CE programs work similarly to their counterparts on the desktop computer, on-line Help covers basic procedures and the differences between the companion programs and desktop programs. If you need more information on using an Office program, see the documentation that came with the desktop version of the program.*

Pocket Word: Creating Documents

You use Pocket Word to create documents, such as letters, meeting minutes, and reports. You can also use Pocket Word to open and edit documents created in the desktop version of Word. When you are ready to save a document you created or edited, you can save it in a variety of formats, including Pocket Word (.pwd), Rich Text Format (.rtf), and Word (.doc). If you plan to send the document through e-mail to someone who will be using Word, not Pocket Word, be sure to save it in the Word (.doc) format.

There are three ways to enter text in Pocket Word

- **Using the on-screen keyboard.** To open the on-screen keyboard, double-click on the on-screen keyboard icon at the bottom of the display screen. Enter data with the on-screen keyboard as you would with a regular keyboard.
- **Using a keyboard.** Install a PS/2-style keyboard to the system's PS/2 plug, and enter data using that device.
- **Using Handwriting Recognition.** Refer to the section of Chapter 4 entitled "Using the Handwriting Recognition Utilities" for details on using the handwriter recognition software supplied with your PenCentra 200.

You can type text in either Outline view (see Figure 3-1) or Normal view, and you can easily switch from one view to the other, using the **View** menu. Work in Outline view when taking notes in meetings; use headings to highlight the main points and body text to add details.

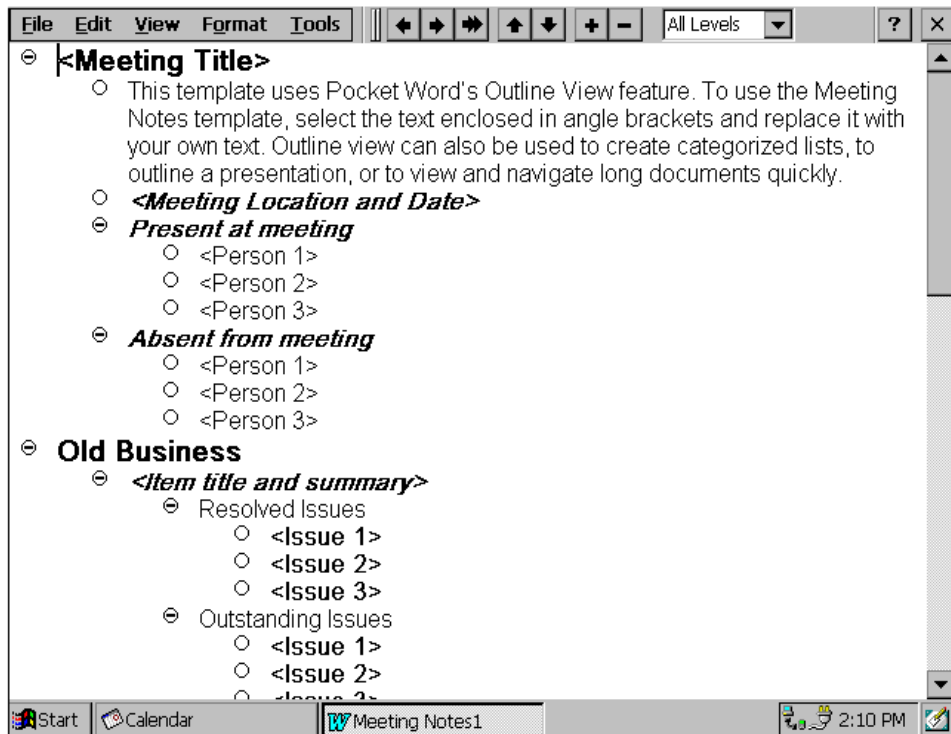

Figure 3-1 Pocket Word Outline View

Taking notes using Pocket Word

1. Select **File, New**, and then **Document from Template**.
2. Select **Meeting Notes** and then **OK**.
3. Select **File** and then **Save**.
4. Enter a name, choose a storage location, and then select **OK**.
5. Replace the text in the Template.

Note: To see more of your document, select **Full Screen** on the **View** menu.

Pocket Excel: Creating Workbooks

You can use Pocket Excel to create workbooks, such as expense reports (see Figure 3-2) and mileage logs. You can also use Pocket Excel to open and edit workbooks created in the desktop version of Excel. When you are ready to save a workbook you created or edited, you can save it in a variety of formats, including Pocket Excel (.pxl) and Excel (.xls). If you plan to send the document through e-mail to someone who will be using Excel, not Pocket Excel, be sure to save it in the Excel (.xls) format.

Pocket Excel provides fundamental spreadsheet tools, such as formulas, functions, sorting, and filtering. You can split panes to easily view different areas of a large worksheet. You can also “freeze” the top and left-most panes in a worksheet to keep row and column labels or other data visible as you scroll through a sheet.

To log expenses using Pocket Excel:

1. Select **File**, **New**, and then **Workbook from Template**.
2. Select **Expense Report** and then **OK**.
3. Select **File** and then **Save**.
4. Enter a name, choose a storage location, and then select **OK**.
5. Replace the text in the template.

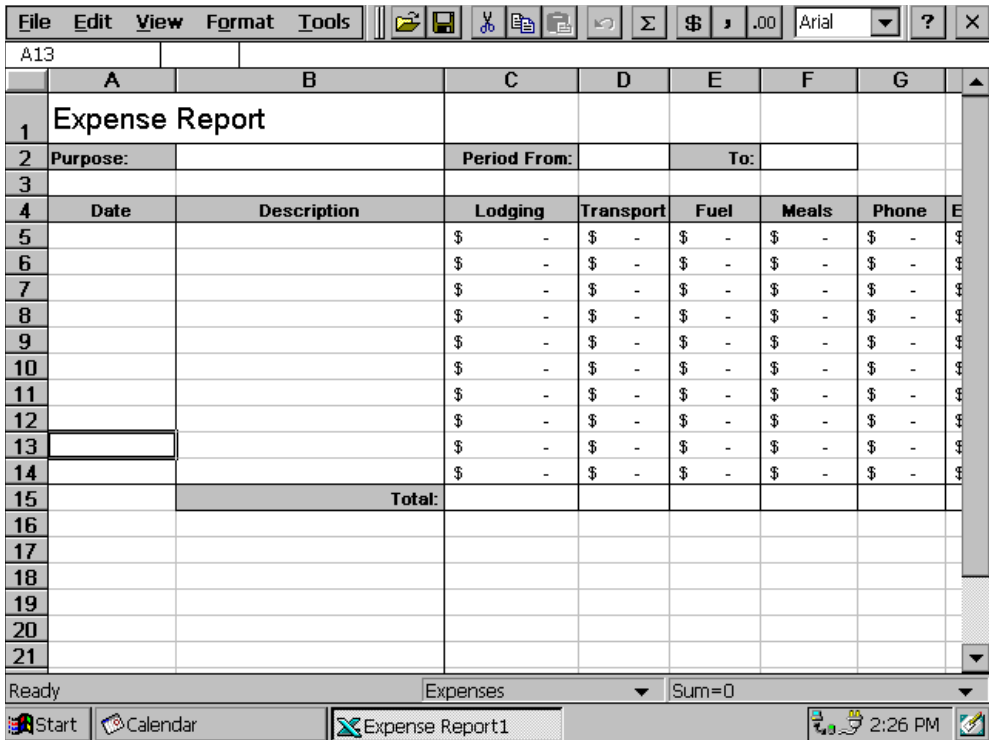

Figure 3-2 Pocket Excel Spreadsheet

Pocket Access: Viewing and Creating Data

Use Pocket Access to view and update data derived from Microsoft Access, Microsoft SQL Server, and other ODBC databases you have created on the desktop computer. Simply create the database on your desktop computer and then transfer the data to your PenCentra 200. For example, a sales organization might use Access on the desktop computer to create a master database of products and order forms (see Figure 3-3). The sales force can synchronize their PenCentra 200s with the master database to get up-to-date product information and to upload completed client order information. For more information on synchronizing, see the section of this chapter entitled “Microsoft Windows CE Services.”

You can also use Pocket Access to create new databases, tables, and SQL procedures directly on your PenCentra 200.

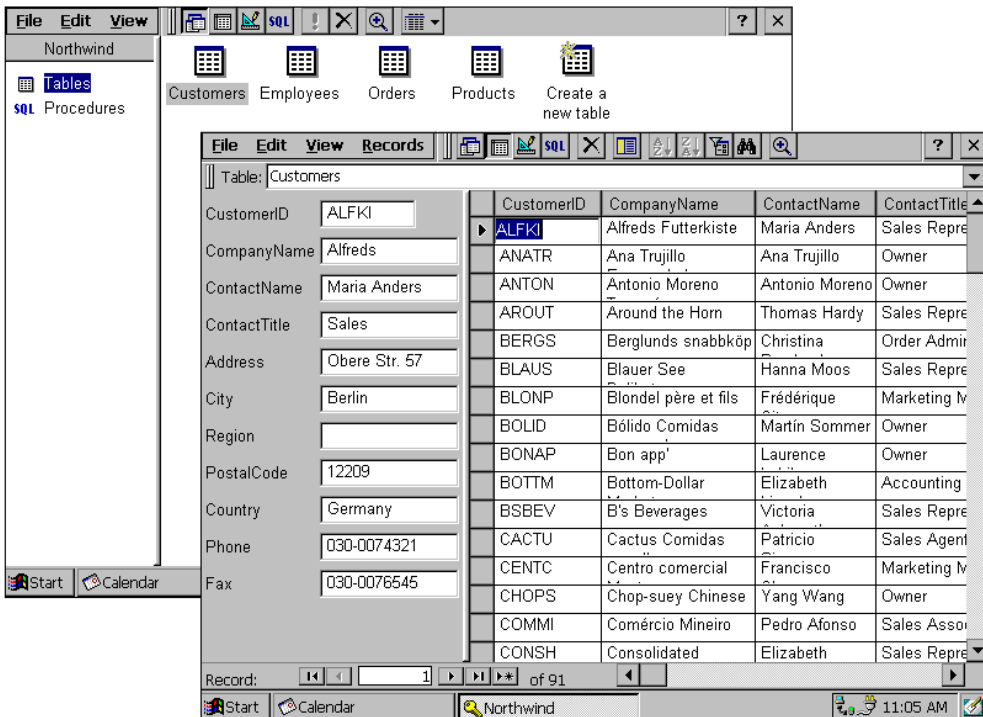

Figure 3-3 Pocket Access Database

To create a new database and table on your PenCentra 200:

1. Select **Start, Programs, Office**, and then **Microsoft Pocket Access**. If Access is already running, select **File** and then **Open/New Database**. If you do not see this command on the menu, select **View** and then **Database View**.
2. Enter a name for the database and select **OK**.
3. Double-tap or double-click the **Create a new table** icon.
4. In the **Field Name** box, enter a name.
5. From the **Data Type** list, select a data type. A field's data type cannot be changed after the table is saved.
6. **Text** boxes have a size limit of 255 characters. To enter longer notes, select the **Memo** data type.
7. To enter numbers with decimal points, select the **Float** data type.
8. To enter numbers between -32,768 and +32,767, select the **Integer** data type.
9. To enter smaller numbers, select the **Small Integer** data type.
10. To set the size limit of a field, enter an amount in the **Field Size** box. A field's size cannot be changed after the table is saved.
11. To index the field, select **Yes** from the **Indexed** list. Indexing a field allows Pocket Access to find and sort information faster for that field.
12. Repeat these steps until you have created all the fields you want for your table.
13. Select **File** and then **Save Table**.

Note: *If you have tables that you don't want to keep updated on your PenCentra 200, mark them as read-only when transferring them from the desktop to save time during future synchronization sessions. Windows CE Services will not check for updates the next time you synchronize.*

Pocket PowerPoint: Showing Presentations

Use Pocket PowerPoint to quickly and easily deliver a professional presentation on your PenCentra 200 (for one-on-one presentations). Simply create the presentation in Microsoft PowerPoint on your desktop computer and then transfer the presentation to your PenCentra 200. Your Pocket PowerPoint file will include the text, pictures, notes, and layout position of the original Microsoft PowerPoint presentation, but will not include animations or slide transitions.

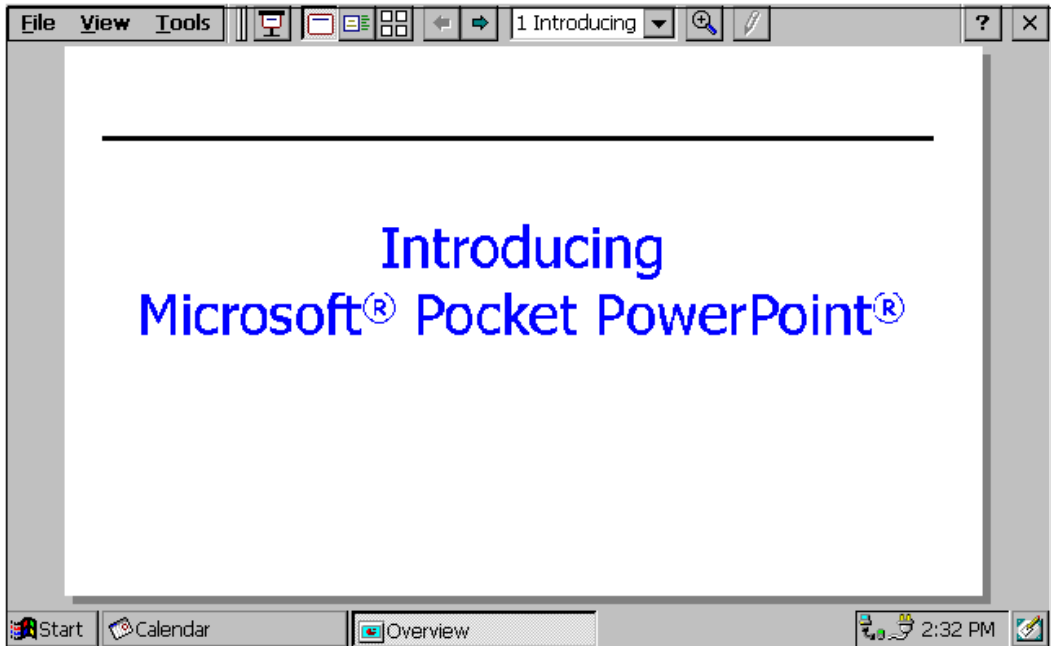

Figure 3-4 Pocket Power Point Display

To show a presentation:

1. Using Windows CE Services, copy the presentation from your desktop computer to your PenCentra 200. For more information, see the section of this chapter entitled "Microsoft Windows CE Services."
2. Select **Start, Programs, Office**, and then **Microsoft Pocket PowerPoint**.
3. In the **Open Presentation** dialog box, select the presentation you want to show, and then **OK**.

4. To change the presentation display and slide advance options, select **Tools** and then **Set Up Show**.
5. To start the show, select **View** and then **View Show**. If you chose **Manual** in step 4, use the **Previous** and **Next** buttons to control the slides.
6. You can tailor a presentation while on the road by adding a new title slide to your presentation. To do so, select **Tools** and then **Title Slide**.

Voice Recorder and InkWriter

Voice Recorder and InkWriter are programs for quickly capturing your ideas, notes, and thoughts. With Voice Recorder, you can record reminders and ideas. With InkWriter, you can take handwritten and typed notes and create drawings.

Note: *More information on the procedures described in this chapter, as well as information on additional procedures, can be found in on-line Help on your PenCentra 200. Select **Start, Help**, and then the program on which you want information.*

Voice Recorder: Capturing Ideas and Thoughts

You can quickly capture ideas, reminders, and phone numbers with Voice Recorder.

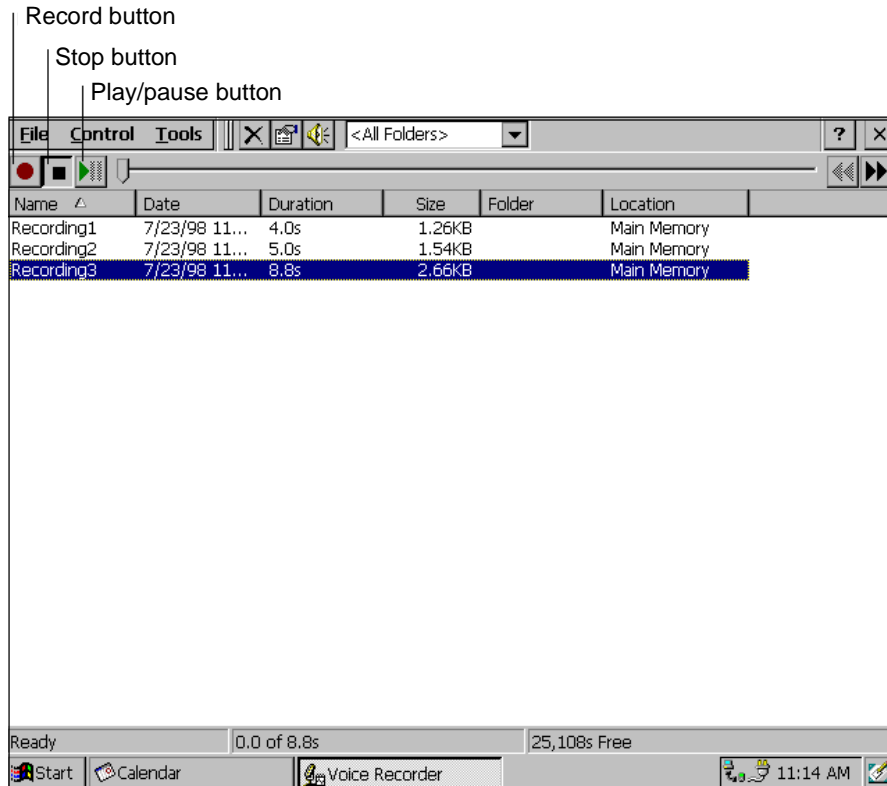

Figure 3-5 Voice Recorder Player

To record and play a recording:

1. Select **Start, Programs, Accessories**, and then **Microsoft Voice Recorder**.
2. Hold your PenCentra 200's microphone near your mouth or other sound source.
3. Select the **Record** button. You'll hear a beep when recording begins.
4. To stop recording, select the **Stop** button. The new recording appears in the recording list.
5. To play a recording, double-tap or double-click it in the recording list. To pause playback, select the **Play/Pause** button. Select **Play/Pause** again to resume playback.

Note: *You can play all of your recordings, one after another. Select the recording you want to play first, select **Control** and then **Play Sequential**. The selected recording and following recordings will be played. A short beep will sound between recordings.*

InkWriter: Creating Notes and Drawings

InkWriter, a text, graphics, and ink processor with Rich Ink technology, makes it easy to write and draw the way you do on paper, but with the benefit of being able to edit and format what you've written and drawn. With InkWriter, you can enter information in the way that's easiest for you. You can type using the keyboard, or you can write and draw directly on the screen using your stylus or pointing device.

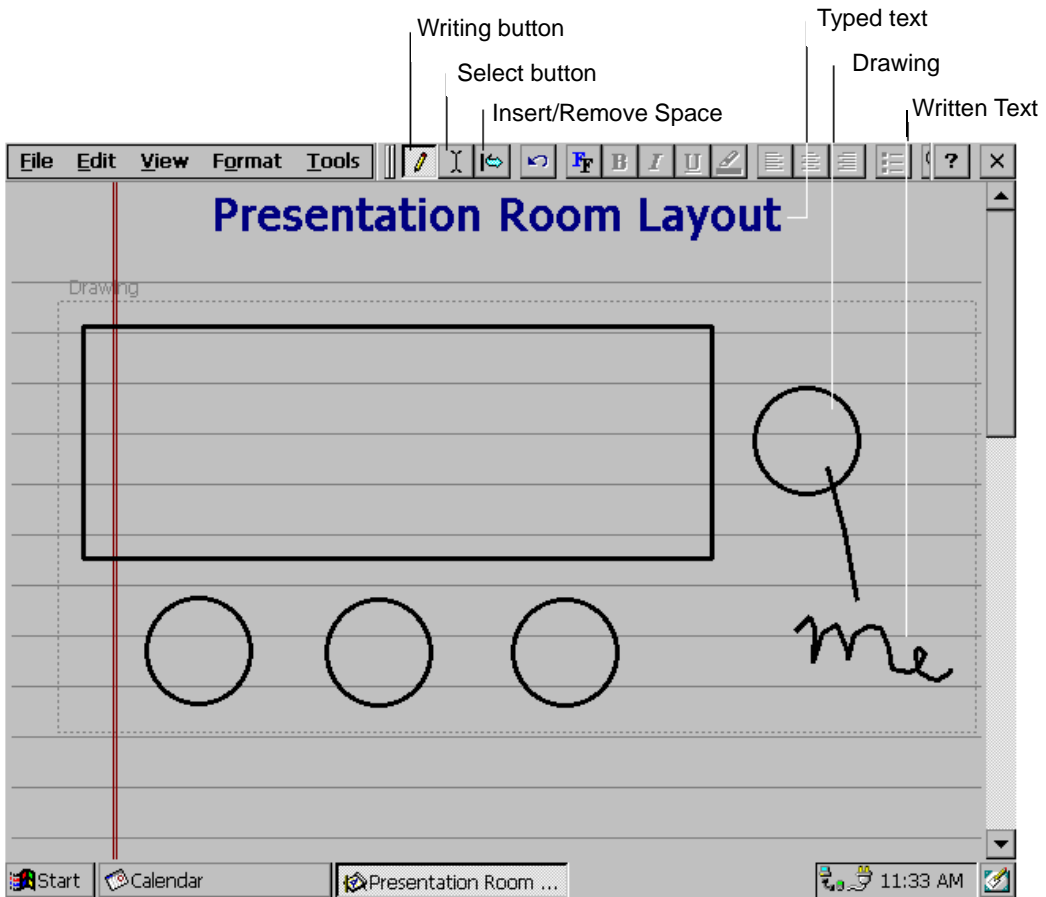

Figure 3-6 Using InkWriter to Create Drawings

To create an InkWriter document:

1. Select **Start, Programs, Accessories**, and then **InkWriter**.
2. Create your document:

- To write, select **View** and then **Writing** and use the stylus like a pen. If you are using a pointing device, click and drag to write on the screen.
- To type, select **View** and then **Typing** and use the keyboard.
- To draw, select **View** and then **Drawing** and use the stylus like a pen. If you are using a pointing device, click and drag to draw on the screen. You can also create a drawing in Writing view by crossing three of the ruled lines on the first stroke of the drawing.

3. When you are finished, select **File** and then **Save**.

Note: *InkWriter can help you draw perfect circles, rectangles, triangles, and lines. In Drawing view, draw the shape you want and use the Select tool to select it. Then, tap on the shape. When the four-headed arrow appears, click on it. Select Choose Shapes, and select the shape you want to convert the shape to.*

Microsoft Pocket Outlook

The Microsoft Pocket Outlook program includes Calendar, Contacts, Tasks, and Inbox. Using Windows CE Services, you can synchronize information in Microsoft Outlook™, Microsoft Schedule+, or Microsoft Exchange on your desktop computer with your PenCentra 200. Each time you synchronize, Windows CE Services compares the changes you made on your PenCentra 200 and desktop computer and updates both computers. For more information, see the section of this chapter entitled “Microsoft Windows CE Services.”

Calendar, Contacts, and Tasks each consists of a card view and list view. The card view is where you enter or view the details for each entry. The list view is where you view all entries. With Inbox, you can send and receive e-mail messages, either through synchronization with Outlook or Exchange on your desktop computer or by connecting directly to your mail server through an Internet or network account.

You can access Pocket Outlook by selecting **Start, Programs, Pocket Outlook**, and then the tool you are interested in.

Note: *More information on the procedures described in this chapter, as well as information on additional procedures, can be found in on-line Help on your PenCentra 200. Select **Start, Help**, and then the program you want information on.*

Calendar: Scheduling Meetings and Appointments

Use Calendar to schedule appointments, meetings, and other events. You can check your appointments in one of several views (Day, Week, Month, Year, and Agenda) and easily switch among the views by selecting the corresponding toolbar button.

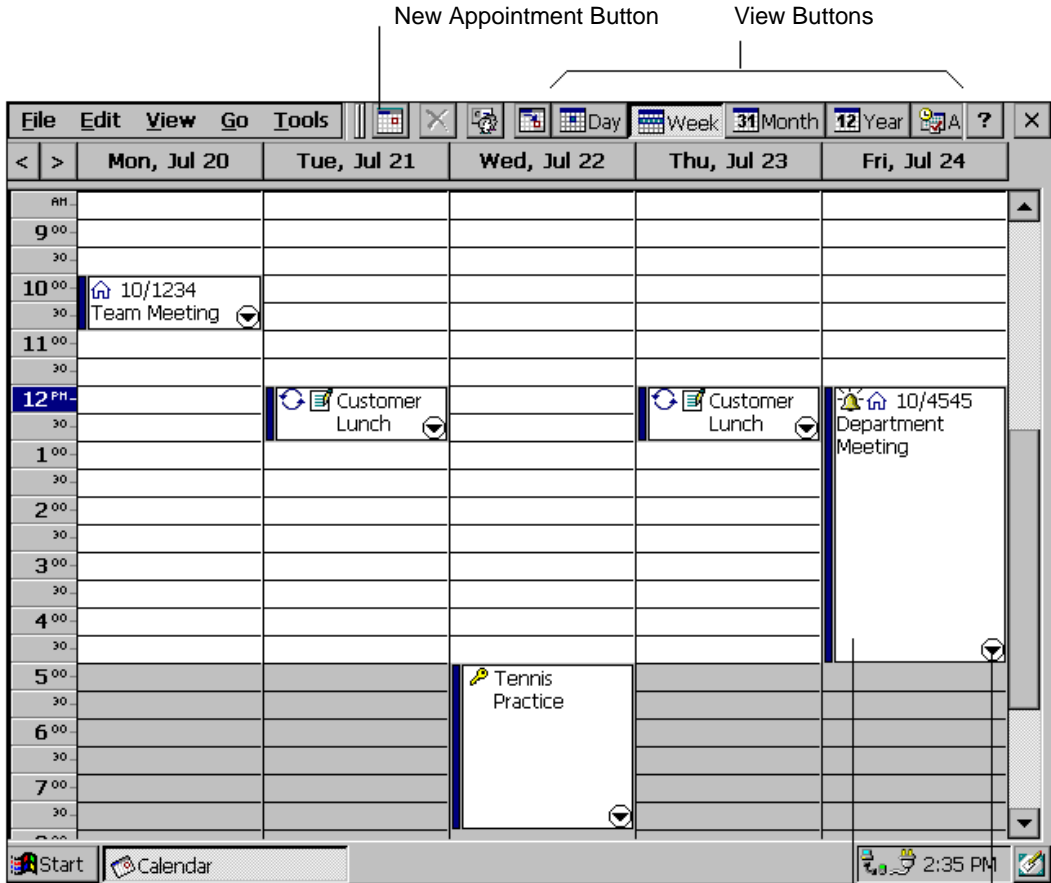

Double-tap or double-click to display or edit the appointment card.

Select to display/hide more information.

Figure 3-7 Pocket Outlook Calendar (Weekly View)

To create a new appointment:

1. From any view, select the **New Appointment** button.
2. Enter a description and a location.
3. Select the time and date.

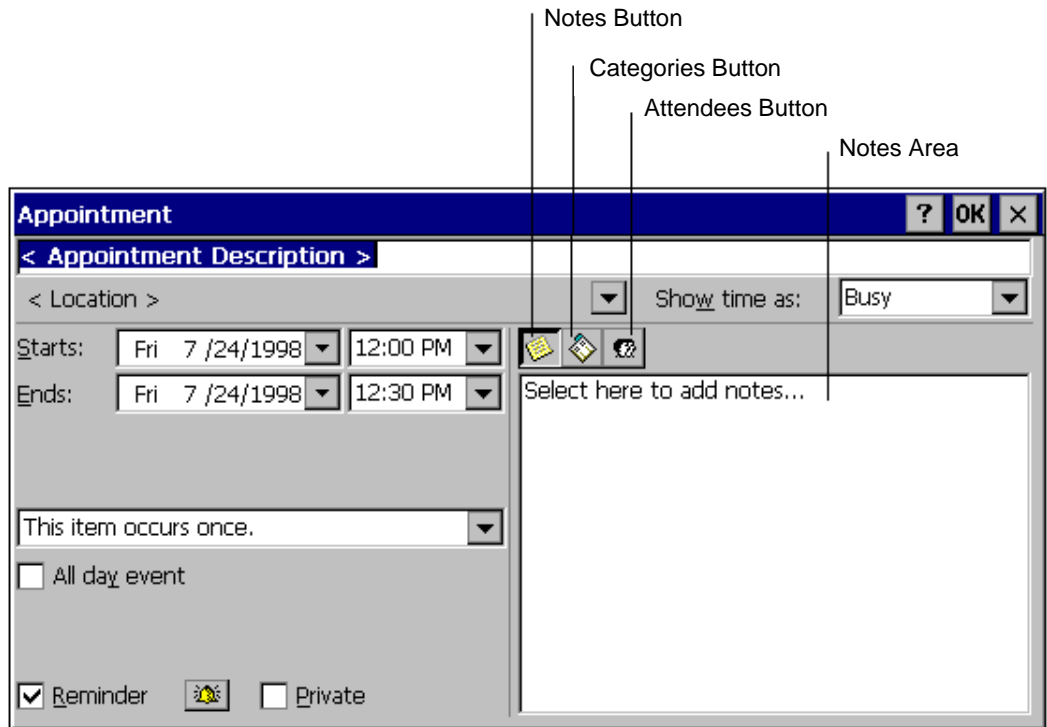

Figure 3-8 Pocket Outlook Appointment Screen

4. To add notes, select the **Notes** button, and then select the notes area. Enter your notes.
5. To assign the appointment to a category, select the **Categories** button and select a category from the list.
6. Select other desired options and then **OK** when finished.

Note: To quickly add an appointment in Day or Week view, select the time and type the description and location. Enter the location in parentheses if you want Calendar to recognize it as the location. For example, "Lunch (Cafeteria)."

If you need to schedule a meeting with people who use Outlook, Pocket Outlook, or Schedule+, you can use Calendar to schedule the meeting. When attendees receive a meeting request, they can choose to accept or decline the meeting. If they accept, the meeting is automatically added to their schedule. In addition, their response is automatically sent back to you, and your calendar is updated.

Before you can send a meeting request, you will need to enter e-mail addresses in Contacts and set up Inbox to send and receive messages. For information on using Contacts and Inbox, see “Contacts: Tracking Friends and Colleagues” and “Inbox: Sending and Receiving E-mail Messages” later in this chapter.

To create a meeting request:

1. Select **Tools, Options**, and then choose a mail transport. If you send and receive messages using synchronization, select **ActiveSync**. If you connect to an ISP or network, select the service you set up in Inbox.
2. Select **File** and then **Make Meeting**.
3. Enter the meeting information.
4. Select the contacts you want to invite.
5. Select other desired options and then **OK**.

Inbox automatically creates a meeting request and sends it to the attendees the next time you connect to your mail server or synchronize with your desktop computer.

Note: *Your PenCentra 200 will remind you about your appointments and meetings by sounding an alarm, flashing the notification light, or displaying a message on the screen. To change how you are notified, select **Tools** and then **Options**. Select the **Alarm** button and then **Reminder Options**.*

Contacts: Tracking Friends and Colleagues

Contacts maintains a list of your friends and colleagues so that you can easily find the information you're looking for, whether you're at home or on the road. Using the PenCentra 200's infrared port, you can also quickly share Contacts information with other Windows CE-based mobile device users.

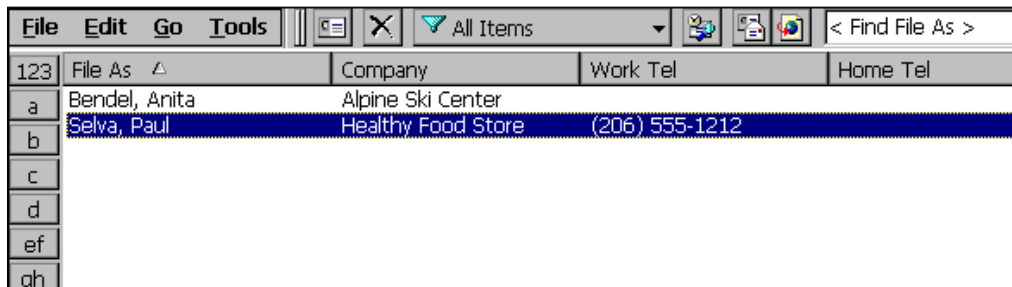

Figure 3-9 Pocket Outlook Contacts Screen

To create a new contact:

1. Select **File**, then **New Contact**.
2. Enter a name.
3. Select the **Business** or **Personal** button and enter information in the appropriate fields. Supply an e-mail address if you want to send meeting requests and e-mail messages to this contact.
4. To add a note or assign the contact to a category, select the **Notes/Categories** button. Then select the notes area and enter your notes, or select a category from the list.

Note: You can send up to 25 contact cards at a time to another Windows CE-based device. Line up the infrared ports on the two devices so that they are within three feet (one meter) of one another and that the viewing angle between the devices is not more than 15 degrees from center line. Be sure that there is a clear line-of-sight path between the devices. In the Contacts list, select the item(s) you want to send, then **File**, and then **Send**. If you are receiving item(s), select **File** and then **Receive**.

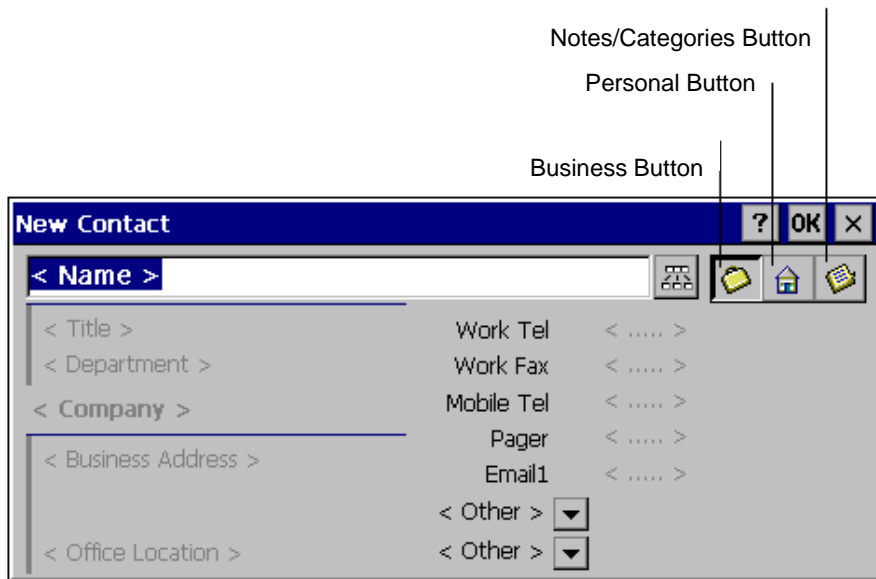

Figure 3-10 Adding a New Contact

Tasks: Keeping a To Do List

Use Tasks to keep track of what you have to do. Overdue tasks are displayed in bold (and in red on color devices).

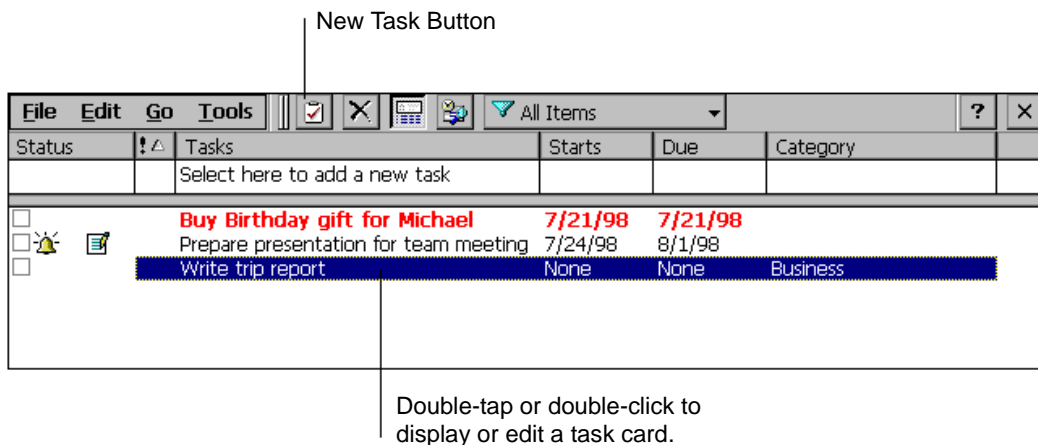

Figure 3-11 Keeping a To Do List

To create a new task:

1. Select the **New Task** button.
2. Enter a description.
3. Select the start date, due date, and other information.
4. To add notes, select the **Notes** button and then the notes area. Enter your notes.
5. To assign the task to a category, select the **Categories** button and select a category from the list.
6. Select other desired options and then **OK**.

Note: To mark a task as complete, in the task list, select the check box in the Status column. To delete all completed tasks, select **Edit** and then **Delete Completed Tasks**.

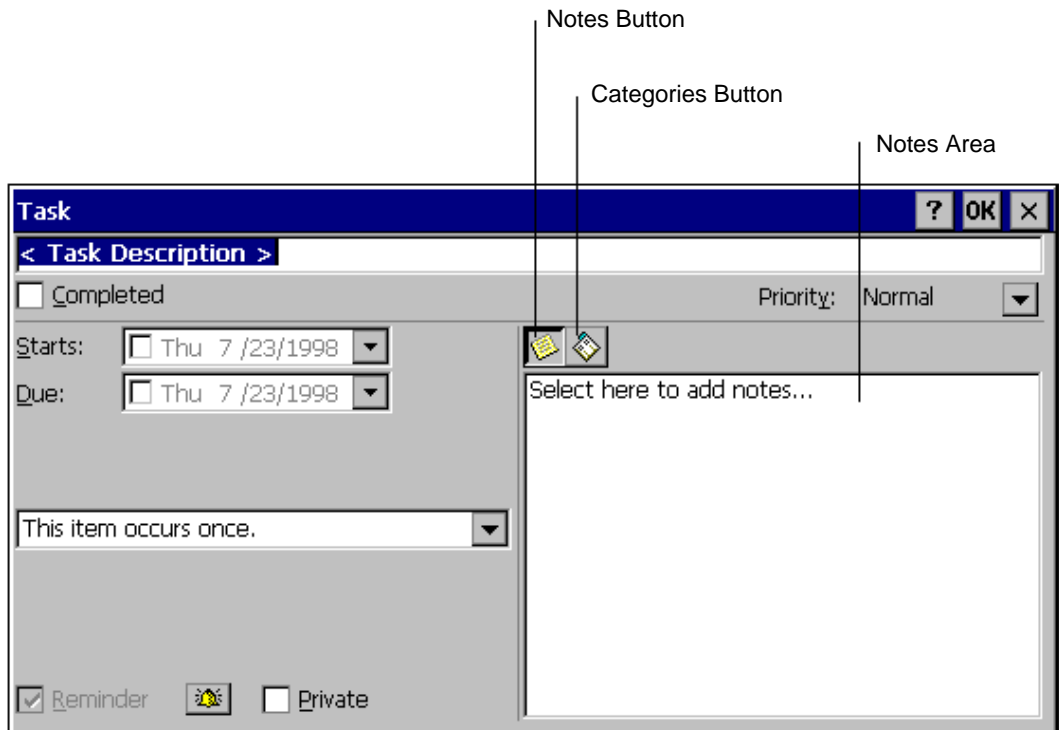

Figure 3-12 Creating a New Task

Inbox: Sending and Receiving E-mail Messages

Use Inbox to send and receive e-mail messages. You can access your e-mail by connecting to a mail server through an Internet or network account or by synchronizing with your desktop computer.

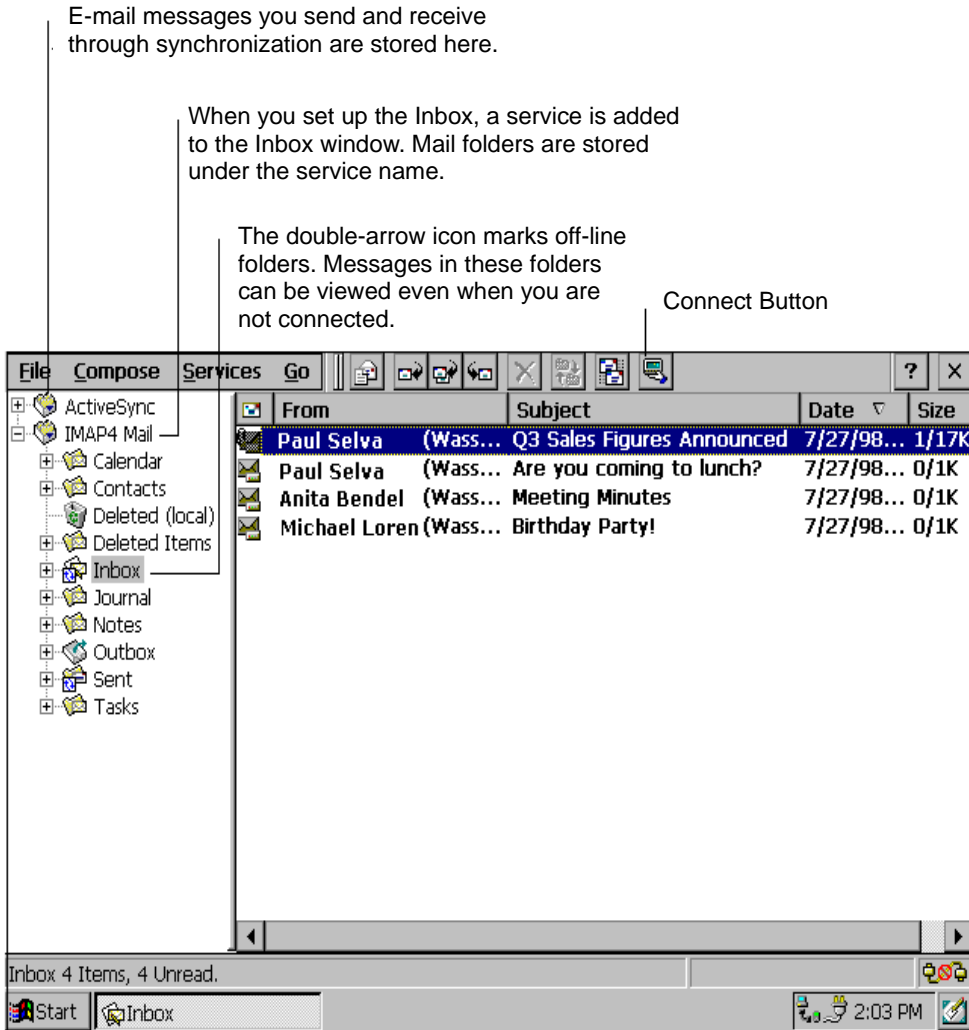

Figure 3-13 Sending and Receiving E-mail

Connecting to a mail server

You can send and receive messages by connecting directly to your mail server. Use a modem to connect to your Internet service provider (ISP), or use a modem or Ethernet card to connect to the local area network that your mail server is connected to. In addition to creating a connection to your ISP or network, you must give Inbox the information it needs to communicate with your mail server.

Note: *Inbox does not currently support connecting with proprietary mail protocols such as AOL® and MSN™. However, you can still gain access to the Internet through these services. There may be third-party programs available that would enable you to send and receive mail through proprietary protocols. Try searching the Internet on the keyword “Windows CE” to find third-party programs for your PenCentra 200.*

Setting up Inbox for connecting to a mail server

1. Get the following information from your ISP or network administrator: POP3 or IMAP4 server name, SMTP host name, user name, password, and domain name (for network connections only).
2. Select **Start, Programs, Pocket Outlook**, and then **Inbox**.
3. Select **Services** and then **Options**.
4. On the **Services** tab, select **Add**.
5. Choose **IMAP4 Mail** or **POP3 Mail**, enter a name for the connection, and then select **OK**.
6. In the **Mail Service Definition** dialog box, enter the information from step 1. In **Connection**, choose the remote connection you want to use. (If you are receiving e-mail through a network connection, Select **Network Connection**.) If you have not created a connection, select **Create new connection**, double-tap or double-click the **Make New Connection** icon, and follow the instructions in the wizard. When finished, select **Inbox** in the Taskbar and continue setting up Inbox. For more information, see “Chapter 6: Getting Connected Remotely.”
7. In the **Mail General Preferences** dialog box, select desired options.
8. In the **Mail Inbox Preferences** dialog box, select desired options.
 - In **When Getting Messages**, choose how you want messages downloaded by default. Choosing **Get full copy of messages** will take up more storage space on your PenCentra 200. Choosing **Only synchronize Inbox folder hierarchy** (IMAP4 only) will speed up the time it takes to download your messages.

- In **When Getting Full Copy**, choose whether you want to download file attachments and meeting requests when you get full copies of messages. This setting applies whether you have chosen to download full copies of messages by default, or if you selectively download full copies of messages by opening the message and selecting the **Get Full Copy** button. In addition, if you want to receive meeting requests, your Exchange Server administrator must enable support for Rich Text Format for your account. Ask your administrator if this feature is enabled for you.

Downloading messages

To send and receive e-mail, select the **Services** menu and make sure that the service you want to use is selected (the selected service has a bullet next to it.) Then, select the **Connect** button. When you connect to the mail server, the messages on your PenCentra 200 and mail server are synchronized: new messages are downloaded to the PenCentra 200 Inbox folder, messages in the Outbox folder are sent, and messages that have been deleted on the server are removed from the Inbox. These folders are stored under the service you created when setting up Inbox. Double-tap or double-click a message in the message list to open it. If you read a message and decide that you need the full copy, select the **Get Full Copy** button.

Disconnecting from the server

To disconnect Inbox from your mail server, select the **Connect** button again. You also need to disconnect your dial-up connection by double-tapping or double-clicking the icon in the status bar and selecting **Disconnect**.

Managing messages and folders

By default, messages are displayed in one of four folders in the service you created: Inbox, Deleted (local), Outbox, and Sent. The Deleted (local) folder contains messages that have been deleted on the PenCentra 200. If you are using IMAP4, you may see a Deleted Items folder. This folder is for deleted messages on the server. The behavior of the Deleted and Sent folders depends on the Inbox options you have chosen.

If you want to organize messages into additional folders, select **File, Folder**, and then **New Folder**. Then, drag messages into the folder you created. The behavior of the folders you create depends on whether you are using POP3 or IMAP4.

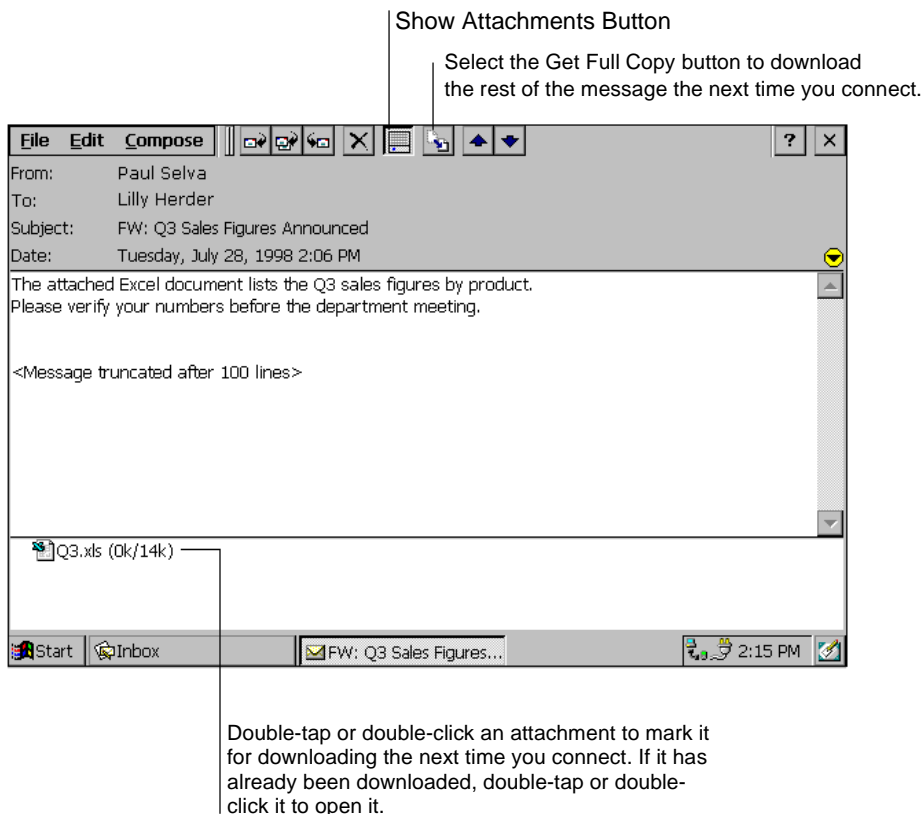

Figure 3-14 Downloading E-mail Messages

If you are using POP3, when you drag messages to a folder you created, the link is broken between the messages and their copies on the mail server. The next time you connect, the mail server will see that the messages are missing from the PenCentra 200 Inbox and delete them from the server. This prevents you from having duplicate copies of a message, but it also means that you will no longer have access to the messages you move to the folders you create from anywhere except your PenCentra 200.

If you are using IMAP4, the folders you create and the messages you move are mirrored on the server. For example, if you move two messages from the Inbox folder to a folder called Family, the server will create a copy of the Family folder and copy the messages into that folder. Therefore, messages are available to you anytime you connect to your mail server, whether it is from your PenCentra 200, laptop

computer, or desktop computer. This synchronization of folders occurs when you create a new folder, move messages into a folder, exit the Inbox program, or select **Synchronize Folders** on the **Services** menu. If you want to view the messages in a folder while disconnected from your mail server, select the folder and then **Off-line Folder** on the **Services** menu.

ActiveSync: Synchronizing E-mail

Another way to access your e-mail is by synchronizing your PenCentra 200 and desktop computer. Using Windows CE Services on your desktop computer, you can send and receive e-mail messages by exchanging information between Inbox on your PenCentra 200 and Inbox in either Outlook or Exchange on your desktop computer. When you synchronize, any changes made on either computer are transferred to the other. If you have received new messages in Inbox on your desktop computer, the messages are copied to your PenCentra 200. If you delete a message on the PenCentra 200, it is deleted from the desktop the next time you synchronize. If you compose and send new e-mail messages on your PenCentra 200, the messages are moved to the desktop computer and sent the next time you synchronize. In addition, changes you've made to Calendar, Contacts, and Tasks are updated.

If you are receiving e-mail by synchronizing with your desktop computer, the PenCentra 200 Inbox is set up by default. However, because e-mail messages are not synchronized by default, you will need to set up Windows CE Services on your desktop computer to include e-mail messages when synchronizing. To do so, select your PenCentra 200 icon in the Mobile Devices folder on the desktop and then click **ActiveSync Options** on the **Tools** menu. Click the **Options** button to set options such as how much of a message to download and whether you want attachments included. You will not be able to change these settings from your PenCentra 200. For specific instructions on setting up and using synchronization, see "Chapter 7: Microsoft Windows CE Services."

Downloading messages

To send and receive e-mail, connect to your desktop computer and initiate synchronization. The way you initiate synchronization depends on how you are connected to your desktop computer and the settings you have chosen in Windows CE Services. For more information, see "Chapter 7: Microsoft Windows CE Services."

When you synchronize, the first 50 lines of new messages in Inbox on the desktop computer are copied to the Inbox folder on your PenCentra 200, and messages in the Outbox folder are sent. These folders are stored under the ActiveSync service in Inbox. Double-tap or double-click a message in the message list to open it.

Managing messages and folders

Messages are stored in one of four folders in the ActiveSync service: Inbox, Deleted (local), Outbox, and Sent. The behavior of the Deleted and Sent folders depends on the Inbox options you have chosen.

If you want to store messages in a folder other than Inbox, select **File, Folder**, and then **New Folder**. Create the folder and then drag messages into it. Doing so breaks the link between these messages and their copies on the desktop computer. When you synchronize next, the messages in the folder you created will not be synchronized. In addition, the desktop computer will see that the messages are missing from the PenCentra 200 Inbox folder and delete them from the Inbox folder on the desktop so that both Inbox folders match. This prevents you from getting duplicate copies of a message, but it also means that you will no longer have access to the messages you move out of Inbox except from your PenCentra 200.

Sending a message

To send a message:

1. Select **Compose** and then **New Message**.
2. Select the **To** field and enter the address of one or more recipients, or select **Address Book** to select addresses from the Contacts list or an address service.
3. Select the **Subject** field and enter a title for the message.
4. Select the message body and type your message.
5. To attach a file, select the **Add Attachment** button.
6. Select the **Send** button.

If you are not connected to your mail server, the message is moved to the Outbox folder and will be sent the next time you connect or synchronize.

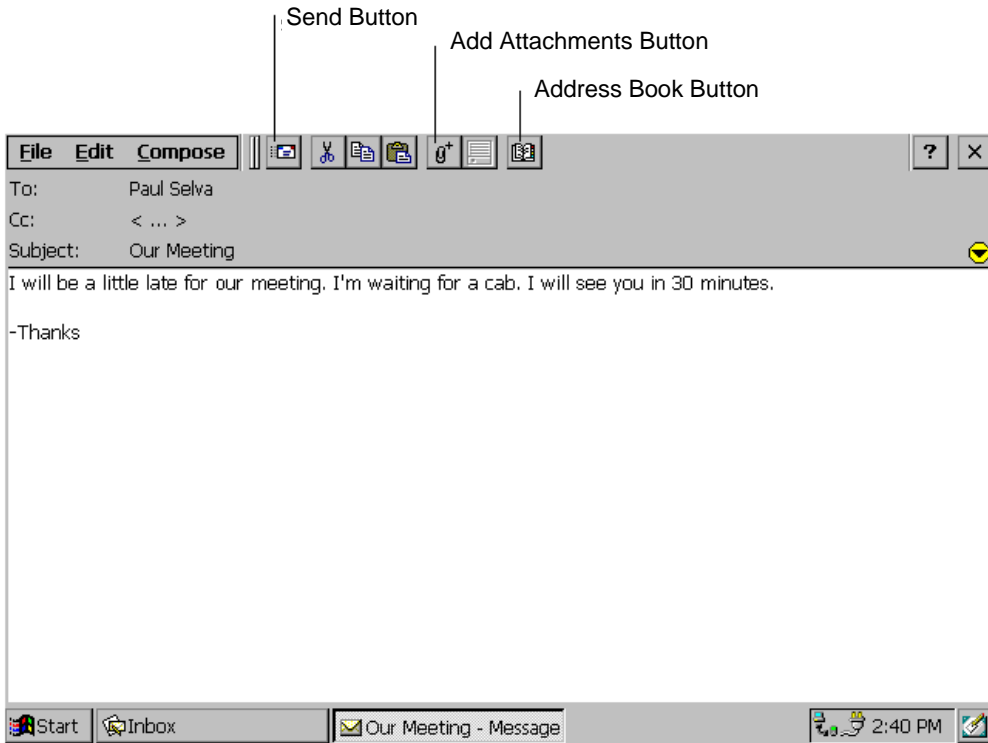

Figure 3-15 Sending an E-mail Message

Getting Connected Remotely

If you want to use your PenCentra 200 to connect to your desktop computer, a network, or the Internet while away from your office, you must create a dial-up connection. This is called *remote networking*. You have the following remote networking options:

- Connect to your Internet service provider (ISP). Once connected, you can send and receive e-mail messages and view Web pages. If this is the method you want to use, see “Connecting to an ISP.”
- Connect to the network at your company or organization. Once connected, you can send and receive e-mail messages, view intranet Web pages, and access files on the network. If this is the method you want to use, see “Connecting to Your Network.”

- Connect to your desktop computer to synchronize remotely. Once connected, you can synchronize information such as your Pocket Outlook data. If this is the method you want to use, see “Connecting to Your Desktop Computer to Synchronize Remotely.” For more information on synchronization, see “Windows CE Services.”

Connecting to an ISP

You can connect to your ISP by creating a dial-up connection. Once connected, you can send and receive e-mail messages and view Web pages.

To create a dial-up connection to an ISP:

1. If your PenCentra 200 does not have a built-in modem, install a modem card.
2. Get the following information from your ISP: ISP dial-up access telephone number, user name, and password.
3. Select **Start, Programs, Communications**, and then **Remote Networking**.
4. Double-tap or double-click the **Make New Connection** icon.
5. Enter a name for the connection, such as “ISP Dial-Up,” select **Dial-Up Connection**, and then select **Next**.
6. Select your modem type.
7. You should not need to change any settings in the **Configure** or **TCP/IP Settings** dialog boxes. Most ISPs now use server-assigned addresses. If the ISP you are connecting to does not use server-assigned addresses, enter the addresses in the **TCP/IP Settings** dialog box. When finished, select **Next**.
8. Enter the access phone number and select **Finish**.

Once you have created the dial-up connection, you simply double-tap or double-click the connection, enter your user name and password, and select **Connect** any time you want to connect. Once connected, you can use Pocket Internet Explorer to visit Web pages or Inbox to send and receive e-mail. Before you can use Inbox, you need to provide the information it needs to communicate with the mail server. For specific instructions, see “Inbox: Sending and Receiving E-mail Messages” in Chapter 5.

Connecting to Your Network

If you have access to a network, you can send e-mail, access file servers, view intranet pages, and possibly access the Internet. You can connect to your network in one of two ways:

- Create a dial-up connection using a RAS account. Before you can create this dial-up connection, your network administrator will need to set up a RAS account for you. If this is the method you want to use, see “To create a dial-up connection to a network.”
- Use an Ethernet card and a net tap to connect to the network. If this is the method you want to use, see “To create a network (Ethernet) connection.”

To create a dial-up connection to a network:

1. If your PenCentra 200 does not have a built-in modem, install a modem card.
2. Get the following information from your network administrator: corporate dial-up access telephone number, user name, password, and domain name.
3. Select **Start, Programs, Communications**, and then **Remote Networking**.
4. Double-tap or double-click the **Make New Connection** icon.
5. Enter a name for the connection, such as “Corporate Dial-Up,” select **Dial-Up Connection**, and then select **Next**.
6. Select your modem type. You should not need to change settings in the **Configure** or **TCP/IP Settings** dialog boxes. When finished, select **Next**.
7. Enter the access phone number and select **Finish**.

Once you have created the dial-up connection, you simply double-tap or double-click the connection, enter your user name, password, and domain, and select **Connect** any time you want to connect. Once connected, you can use Pocket Internet Explorer to visit intranet Web pages and Inbox to send and receive e-mail. Before you can use Inbox, you need to provide the information it needs to communicate with the mail server. For specific instructions, see “Inbox: Sending and Receiving E-mail Messages” earlier in this chapter.

To create a network (Ethernet) connection:

You do not need to create a new connection in Remote Networking on your PenCentra 200 for a network connection. Instead, you must install and configure an

Ethernet card. You must have an NE2000-compatible Ethernet card. The drivers for the card already exist on your PenCentra 200.

1. Insert the Ethernet card into your PenCentra 200 and connect it to your network cable.
2. You may see a message warning about battery power. If you have an A/C Adapter, plug it into your PenCentra 200.
3. Perform one of the following steps, depending upon whether the **Settings** dialog box opens automatically.
 - If the **Settings** dialog box is displayed automatically, enter the information for your server. See your network administrator if you need assistance. You should not have to change these settings.
 - If the **Settings** dialog box is not displayed automatically, go to **Start, Settings, Control Panel**, and double-tap or double-click **Network**. Select your Ethernet driver and select **Properties**.
4. Select **Start, Settings, Control Panel**, and double-tap or double-click **Network**. In the **Identification** tab, enter your name, password, and domain.

Once connected, you can use Pocket Internet Explorer to visit intranet Web pages and Inbox to send and receive e-mail. Before you can use Inbox, you need to provide the information it needs to communicate with the mail server. For specific instructions, see “Inbox: Sending and Receiving E-mail Messages” in Chapter 5.

Connecting to Your Desktop to Synchronize Remotely

To synchronize remotely, the following conditions must be met:

- You must first establish a partnership between your PenCentra 200 and desktop computer while at your desktop computer.
- The desktop computer must be turned on and you must be logged in. Schedule+, Exchange, or Outlook must be running with your user profile.
- In the lower-right corner of the Mobile Devices window, the connection status must show **Waiting for mobile device to connect**.
- In the **ActiveSync Options** dialog box in Windows CE Services, synchronization must be enabled. (Or you can select **Automatically synchronize if data is out-of-date**.)

- If you are communicating through a modem connected to the desktop computer, the modem must be turned on. Also, the **Auto Connect** should be set to **At all times** in Windows CE Services. Otherwise, a Mobile Devices window must be open.
- If you are communicating with the desktop computer through a dial-up or network connection, you must be logged on to the network on the desktop computer. Before you leave, select **Enable a network connection** in the **Windows CE Services Properties** dialog box.

If your computer must be turned off while you are away from your office, you cannot synchronize remotely. However, you can dial in directly to your network to receive your e-mail. For more information, see “Connecting to Your Network.”

If the above conditions are met, you can synchronize with your desktop computer while away from the office in one of three ways:

- Create a dial-up connection using a RAS account. Before you can create this dial-up connection, your network administrator will need to set up a RAS account for you. Once connected to the network, your PenCentra 200 will find your desktop computer and initiate synchronization. If this is the method you want to use, see “To create a dial-up connection to a network.” Once the connection has been created and you are connected, select **Start, Programs, Communications**, and then **ActiveSync** on your PenCentra 200. In the **ActiveSync** dialog box, select the dial-up connection you created as the method to connect and the name of the computer you want to connect to.
- Use an Ethernet card to connect to the network. Once connected to the network, your PenCentra 200 will find your desktop computer and initiate synchronization. If this is the method you want to use, see “To create a network (Ethernet) connection.” Once the connection has been created and you are connected, select **Start, Programs, Communications**, and then **ActiveSync** on your PenCentra 200. In the **ActiveSync** dialog box, select **Network Connection** as the method to connect and the name of the computer you want to connect to.
- Create a dial-up connection to a modem connected directly to your computer. The modem must be set up to answer incoming calls. If this is the method you want to use, see “To create a dial-up connection to a modem attached to your desktop computer.” Once the connection has been created and you are connected, select **Start, Programs, Communications**, and then **ActiveSync** on your PenCentra 200. In the **ActiveSync** dialog box, select the dial-up connection you created as the method to connect and the name of the computer from the **Connect to** list.

To create a dial-up connection to a desktop modem

Note: *If you are a Windows 95 user, you will need to install the Dial-Up Networking Upgrade 1.2 and create a user account if User Level Access is enabled in Dial-Up Networking. If you are a Windows 98 user, you will need to add a second dial-up adapter. For more information, see Windows CE Services Help.*

1. Follow the modem manufacturer's directions to install a modem on your desktop computer.
2. Note the telephone number for your desktop computer modem.
3. On your desktop computer, open the Mobile Device folder. Click **File** and then **Communications**.
4. Under **Device Connections via Serial Port**, click your modem in the **Ports** list.
5. Click **Enable mobile device connection**.
6. Click **Enabled** in both **Device Connections via Serial Port** and **Device Connections via Network**.
7. Follow the steps in "To create a dial-up connection to an ISP" to create the connection. Substitute the phone number you noted in step 2 for the ISP dial-in number.

Getting Help on Connecting Remotely

More information on the procedures described here, as well as information on additional procedures, can be found in the following locations:

- "Inbox: Sending and Receiving E-mail Messages" in this chapter.
- "Microsoft Windows CE Services" in this chapter.
- On-line Help on your PenCentra 200. Select **Start, Help**, and then **Inbox, Remote Connections**, or **Synchronization**.
- Windows CE Services online Help on the desktop computer. Open the Mobile Devices folder and then click **Windows CE Services Help Topics** on the **Help** menu. Troubleshooting information is also contained here.

Microsoft Windows CE Services

Microsoft Windows CE Services with ActiveSync enables you to *synchronize* the information on your desktop computer with the information on your PenCentra 200. Synchronization is the process of comparing the data on your PenCentra 200 with your desktop computer and updating both computers with the most recent information. For example:

- Keep Pocket Outlook data up-to-date by synchronizing your PenCentra 200 with your choice of Microsoft Outlook (Inbox synchronization with Outlook Express is not currently supported), Microsoft Schedule+, or Microsoft Exchange on your desktop computer.
- Synchronize Word and Excel documents, Access and other ODBC databases and tables, and InkWriter documents between your PenCentra 200 and desktop computer. Your files are automatically converted to the correct format.
- With Windows CE Services, you can also:
 - Back up and restore your PenCentra 200 data.
 - Add and remove programs on your PenCentra 200.
 - Copy (rather than synchronize) files between your PenCentra 200 and your desktop computer.

Installing Windows CE Services and Setting up a Partnership

1. If you want to upgrade to Microsoft Outlook 98, install it first.
2. Use a standard serial cable to connect your PenCentra 200 to your desktop computer.
3. Insert the Desktop Software for Microsoft Windows CE CD-ROM into your CD-ROM drive.
4. The Windows CE Services Setup Wizard should start automatically. If it doesn't, click the **Start** button, then select **Run**. In the **Open** box, type **d:\setup**, where **d** is your CD-ROM drive. Click the **OK** button.
5. Follow the directions on your screen.

Once installation is complete, a wizard will instruct you to connect your PenCentra 200 and desktop computer and guide you through setting up a partnership and performing your first synchronization. Some items, such as messages, are not synchronized by default. To change the type of items that get synchronized after

you've completed the wizard, select your device icon in the Mobile Devices folder and then click **ActiveSync Options** on the **Tools** menu.

If you are synchronizing with a computer running Windows 95/98, you can also use an infrared connection to synchronize. For more information, see Windows CE Services Help.

Note: *Regularly back up your PenCentra 200 data on your desktop computer using Windows CE Services in case information on your PenCentra 200 is ever corrupted or lost. Connect your PenCentra 200 and then click **Backup/Restore** on the **Tools** menu in the Mobile Devices folder on your desktop computer. Your first back up may take some time, depending on how much information you have on your PenCentra 200. Subsequent backups will be faster if you select **Incremental**.*

Synchronizing Files and File Conversion

One way to move documents to your PenCentra 200 is to simply connect your device and desktop computer, open your device icon in the Mobile Devices folder, and drag the files. Copies of the files will be placed on your PenCentra 200, and files will be automatically converted to a format that the PenCentra 200 can read. However, if you have documents that you update frequently on both your PenCentra 200 and desktop computer, you may want to synchronize the copy on your desktop computer with the one on your PenCentra 200 so that you always have an up-to-date copy on both computers. To do so, store the files you want to synchronize in the Synchronized Files folder on the PenCentra 200 and desktop computer. During synchronization, files are updated in both locations.

Note: *On the PenCentra 200, the Synchronized Files folder is in the My Documents folder. On the desktop computer, the Synchronized Files folder is called "device Synchronized Files", where "device" is the name of your PenCentra 200. If you are using Windows 95/98, the folder is located in the My Documents folder (c:\My Documents\device Synchronized Files). If you are using Windows NT, the folder is located in the Personal folder (c:\Winnt\Profiles\your username\Personal\device Synchronized Files).*

When you transfer a file from your desktop computer to your PenCentra 200, the file is converted to a format that the PenCentra 200 can read. During file conversion, some of the file's attributes may be changed or removed, and the file extension is changed. For example, when you transfer a Microsoft Word file to your PenCentra 200, some of the file's formatting may be removed or changed, and the file extension is changed to .pwd (Pocket Word). When this file is transferred back to the desktop computer, the file extension is converted back to .doc, but any changed or removed formatting will still be lost. Therefore, if you are using the Synchronized Files folder to transfer files and you want to preserve all formatting in the original document,

keep a copy of the original file in another folder. See Windows CE Services Help for specific information on how file attributes are affected during conversion.

Note: *If you have password protection on an Excel or Word file on your PenCentra 200, you must first turn off the password protection before the file is synchronized with the desktop computer. To do so, open the file, select **File**, select **Password**, and clear the **Password** field*

Remote Synchronization

Note: *Be sure to log out of CE Services prior to removing the serial cable. If you do not log out, CE Services will continue to look for a connection when the cable is not installed.*

You can synchronize with your desktop computer while away from the office by connecting to your network or directly to your computer via a modem attached to your computer. For more information, see “Connecting to Your Desktop Computer to Synchronize Remotely” earlier in this chapter.

Getting Help on Windows CE Services

For additional setup, usage, and troubleshooting information, see online Help on the desktop computer by choosing **Windows CE Services Help Topics** on the **Help** menu in the Mobile Devices folder.

Chapter 4

Using the Handwriting Recognition Utilities

This chapter contains information about the handwriting utilities on your PenCentra 200.

- CalliGrapher® handwriting recognition utilities are included with PenCentra 200 pen tablets that have Windows CE 2.11 installed.
- Systems with Microsoft H/PC 2000 installed use Handwriter for HPC 2000 -- including Jot -- as a handwriting recognition utility.

The Windows CE-based programs that are loaded on your PenCentra 200 are discussed in Chapter 3.

What is CalliGrapher?

CalliGrapher version 5.3 from ParaGraph adds natural handwriting recognition capability to your PenCentra 200 for all handwriting styles -- cursive, print or mixed.

CalliGrapher analyzes pen strokes written in any application window, converts the pen strokes into text and sends the recognized text to a target application. Employing advanced fuzzy logic and neural net techniques, CalliGrapher recognizes arbitrary alphanumeric strings as well as words from its integrated dictionary.

CalliGrapher also offers a comprehensive spell checker for all Windows® CE 2.11 applications.

CalliGrapher for Windows CE gives you the freedom to enter information quickly and efficiently into your PenCentra 200.

(Portions of this chapter relating to ParaGraph and CalliGrapher are copyright (C) 1998-2000 ParaGraph, a business unit of Vadem. ParaGraph and CalliGrapher are registered trademarks of ParaGraph).

Getting started

Do you see a pen image on the taskbar? It would look like one of these pictures:



The pen image indicates that CalliGrapher is already running. Note that switching your system on and off does not close CalliGrapher. CalliGrapher will produce an error message indicating that it cannot load a DLL if you didn't reset the system when you were asked to do so by the installation program.

Start CalliGrapher (if it is not already running). To do this, find the CalliGrapher icon on your PenCentra 200 desktop. It looks like this:



Double-tap on it (or tap once and then press "Enter").

After CalliGrapher starts, you'll see the pen and the marker images in the taskbar tray (in the bottom right corner of the screen).

Press your pen tip on either of those images and keep it pressed for a while (until you hear a "click") to activate the CalliGrapher menu.

Note: *In CalliGrapher, the operations done by tapping on something and by pressing the pen and waiting for a "click" are often different.*

A check mark appears next to the "Pen" menu item. This confirms that now you can write on the screen:

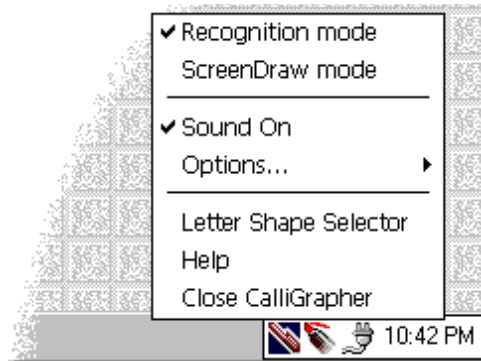

If you tap on "Pen", the ability to use the pen will be turned off, and your stylus will operate as if CalliGrapher is not running.

When the pen is turned off, the pen image in the taskbar tray looks like this:



To turn the pen back on, just tap on the pen image.

The Two Icons Explained

By default, CalliGrapher displays only one icon on the taskbar - the pen icon. If you ever select the drawing mode, the second one - the marker icon - will be added. You can do it by selecting "ScreenDraw" in the CalliGrapher menu.

Any of those may be highlighted, or none at all, like this:

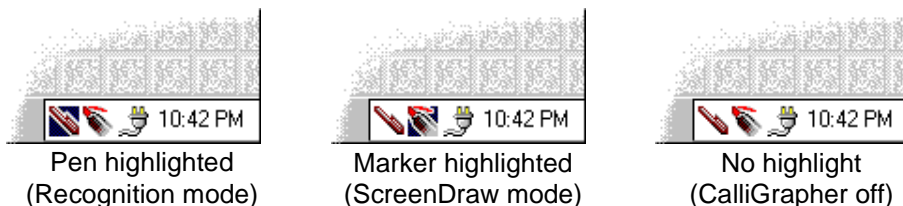

In the Recognition mode, CalliGrapher translates your handwriting into text and pastes in into the active window. This is the mode we'll be discussing here.

In the ScreenDraw mode, you can just draw sketches on top of the screen. This mode will be explained later.

In any mode you still can use the pen for its regular tasks. For example, double-tapping on the desktop icons or tapping on the dialog box buttons will work as usual.

You can switch between modes either by tapping on the appropriate taskbar icon or by selecting the corresponding menu item from the CalliGrapher menu.

Tapping on the icon of the currently selected mode turns CalliGrapher off. Tap on any CalliGrapher taskbar icon to turn it back to the desired mode.

You can select "Options..." from menu to set what icons are shown on a taskbar (tap on the "Icons" tab in the "Options" dialog box).

In all of the following examples we assume that the pen is turned on.

Now start an application such as Pocket Word. Your screen should look like this:

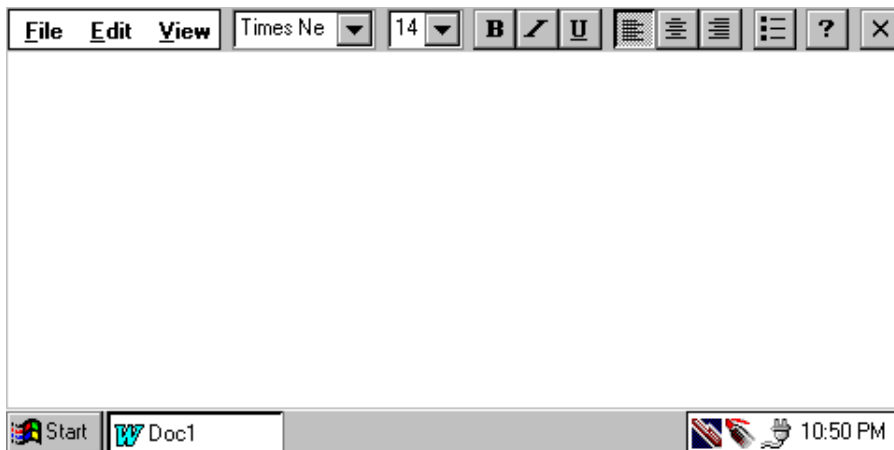

Now you are ready to use CalliGrapher's recognition and spell-checking features.

Basic writing and corrections

CalliGrapher recognizes whole words and phrases. Here is the whole phrase "The quick brown fox" written while running Microsoft's Pocket Word:

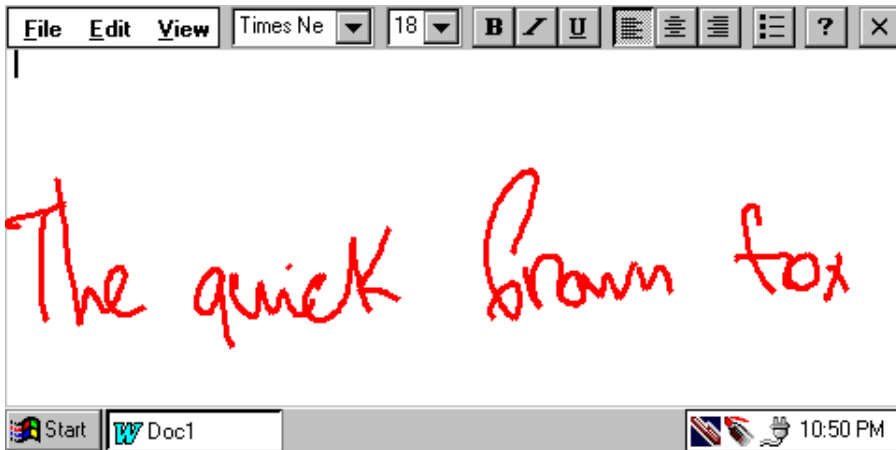

After a short pause, the writing is recognized. Suppose CalliGrapher produces the following:

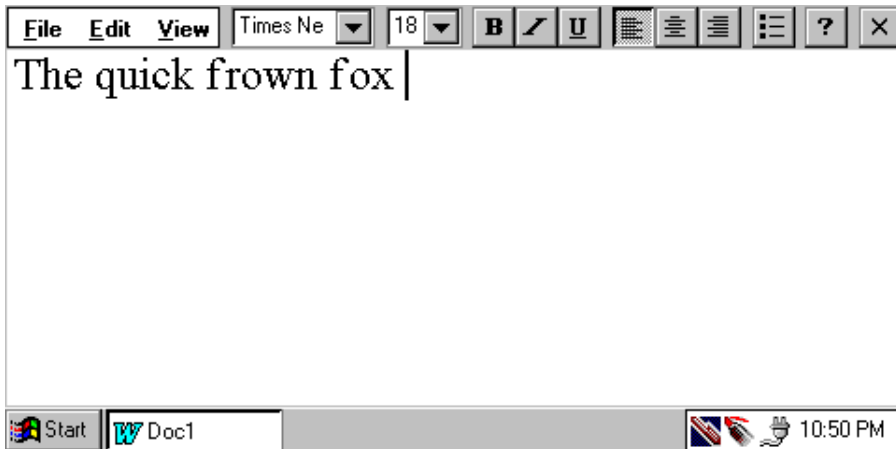

It should be "brown", not "frown". Use the correction gesture to change the text:

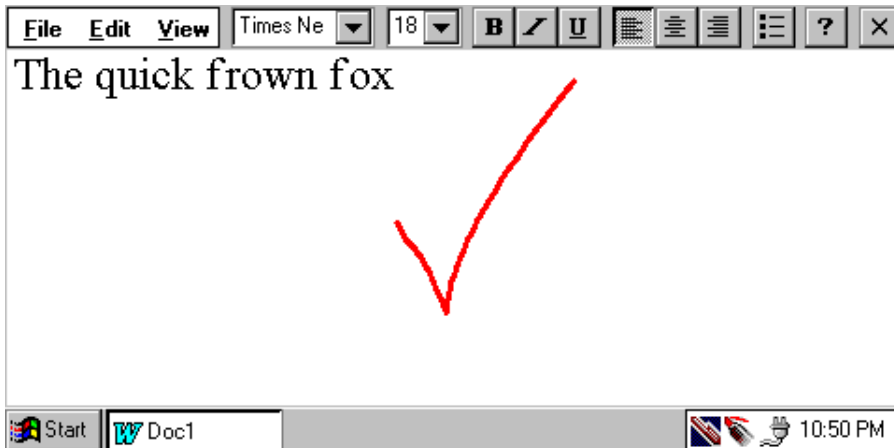

Note that the direction of the gesture is significant.

The gesture should be written from left to right, and the right part should be at least twice as long as the left one, like this:



Now the Correction Window appears:

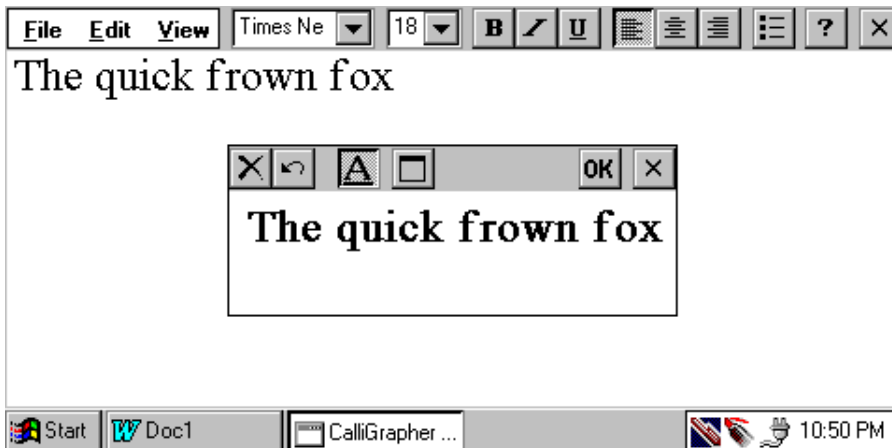

Tap on the word "frown" in the Correction Window. The caret appears under the letter you tapped on. It indicates the place where the changes will be made:



Tap on the caret (or double-tap on the word "frown"). The pop-up menu appears:

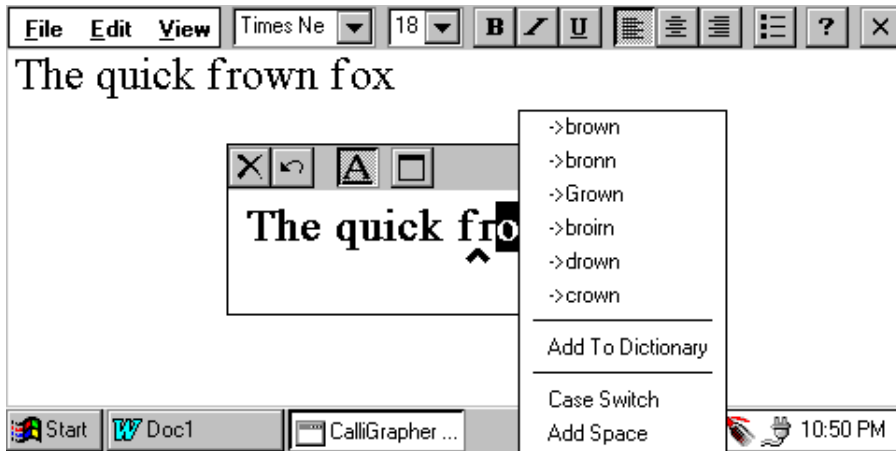

In the top portion of the menu, CalliGrapher gives suggestions for this word, and the word "brown" is among them. When you tap on it "frown" is replaced with "brown" in the Correction Window:



All you have to do now is to tap on the "OK" button in the upper right corner of the Correction Window. The text in Pocket Word changes automatically:

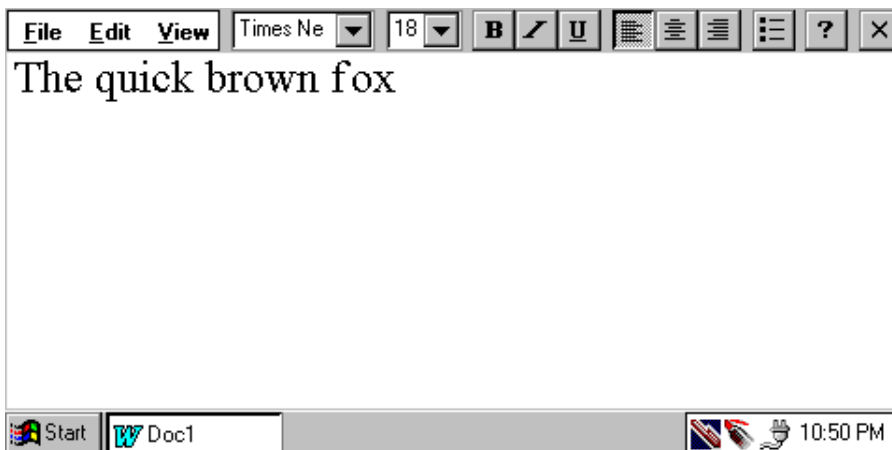

If the right word didn't appear in the menu, simply write the desired letter above the wrong one to correct it:

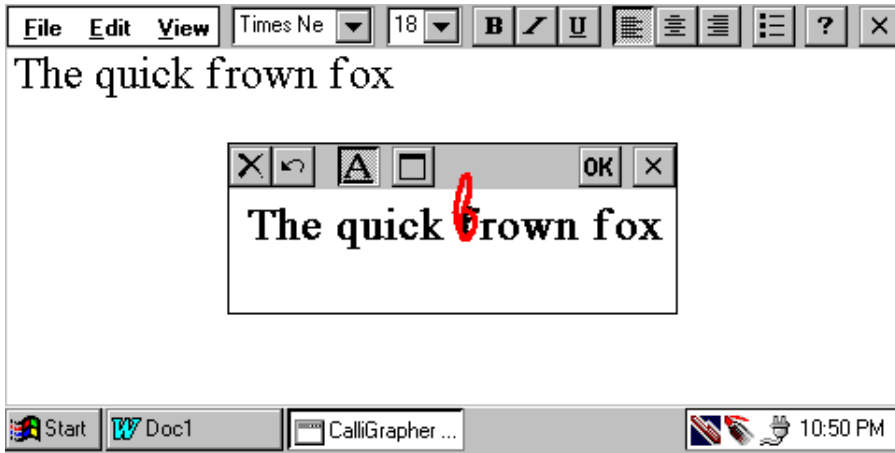

What is displayed in the Correction Window?

How does CalliGrapher know what do you want to correct when you make a correction gesture?

First, if you made a correction gesture just after writing something, and didn't select any text after that, CalliGrapher assumes you want to correct your last written phrase and displays it in the Correction Window.

If you have selected any text in your current application (i.e. Pocket Word), that text would be displayed in the Correction Window.

Finally, if you make the correction gesture and don't lift the pen tip until the correction window is displayed, the whole text in your current application would be selected and displayed in the Correction Window. This is just a shortcut for two actions: selecting all text and then making the correction gesture.

Gestures and spell checking

Spell checking works for all text, whether or not it was originally entered with a pen.

Let's take the phrase from our previous recognition example, "The quick brown fox" and turn it into the complete sentence by adding "jumps over a lazy dog". Change the

word "brown" to "broun". Then make the gesture which means "Run the spelling check for all text":

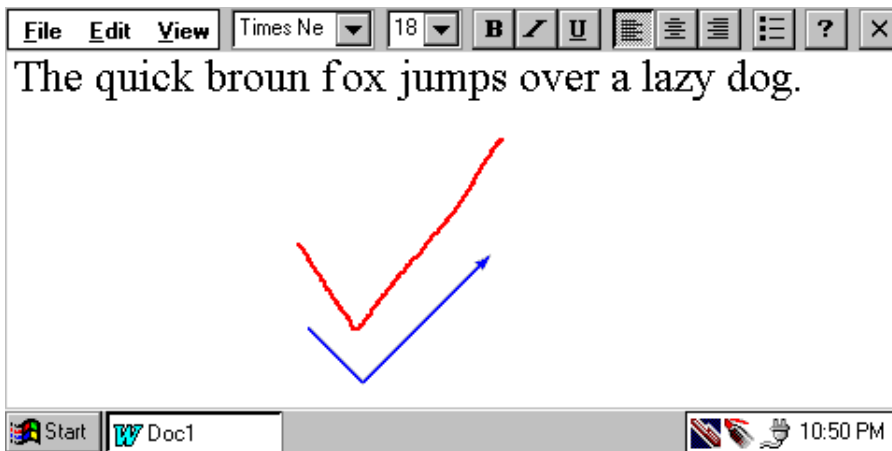

This gesture has to be written as the regular correction gesture, but at the end you should hold the pen pressed to the screen until the Correction Window appears.

Now it contains the entire text from the document. The words that are not in the CalliGrapher vocabulary are highlighted - they are displayed in gray and underlined:

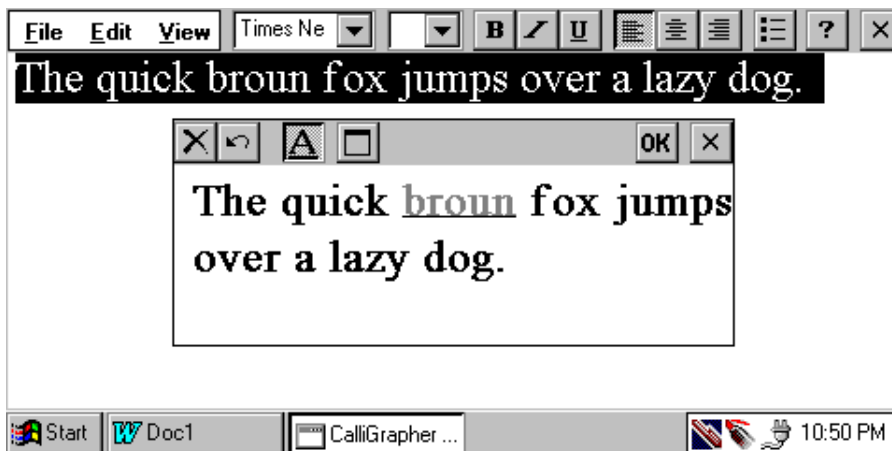

Double-tap on a misspelled word (or tap once on it, then on a caret that shows up after the first tap) - again, the menu appears. It shows suggestions from the

CalliGrapher spell checker for the word "broun" (whereas the earlier correction example used recognition alternatives). Note that the word "brown" is one of them.

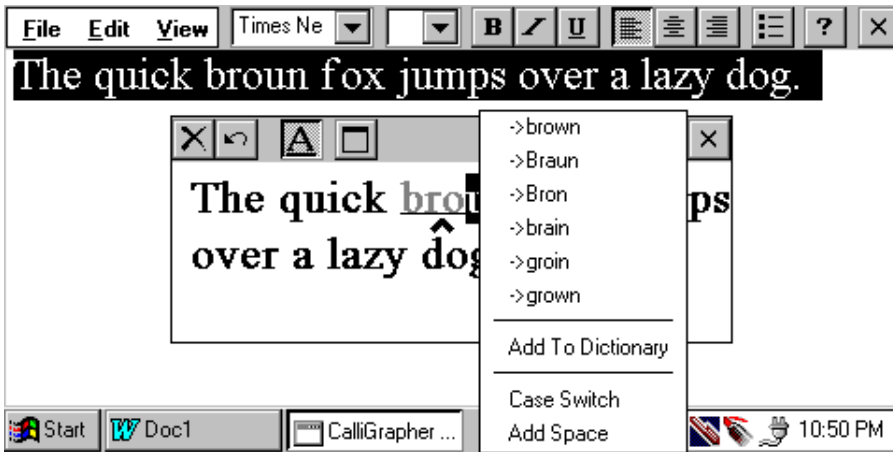

Now select the correct word from the menu, and it replaces the wrong one in the Correction Window:

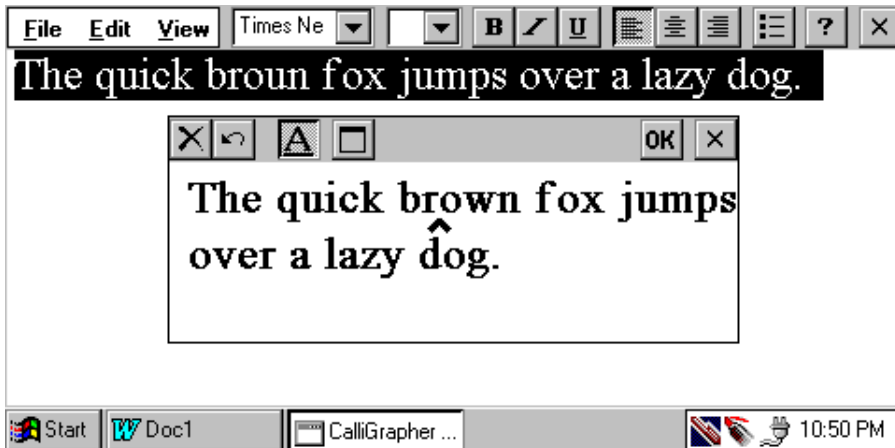

Press the "OK" button. The text in Pocket Word is correct again:

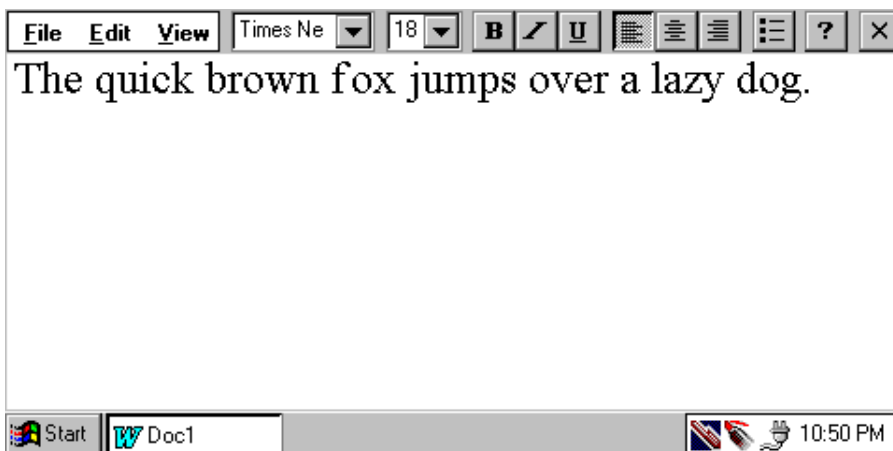

To erase a word, first cross it out with a single horizontal line (from left to right):

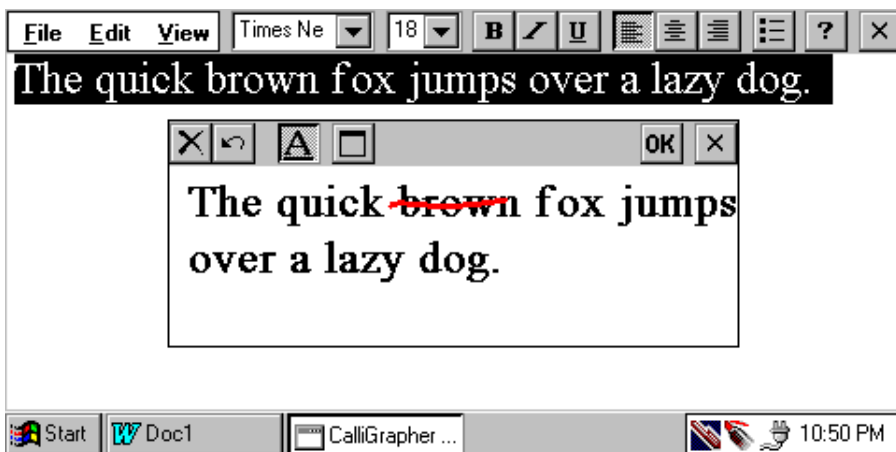

It will become selected:

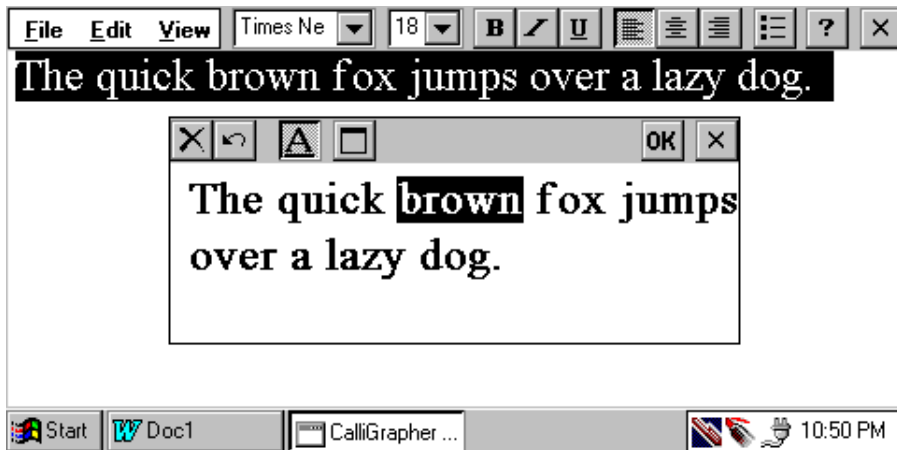

Now just draw the erase gesture (horizontal line from right to left):



Here is the result:

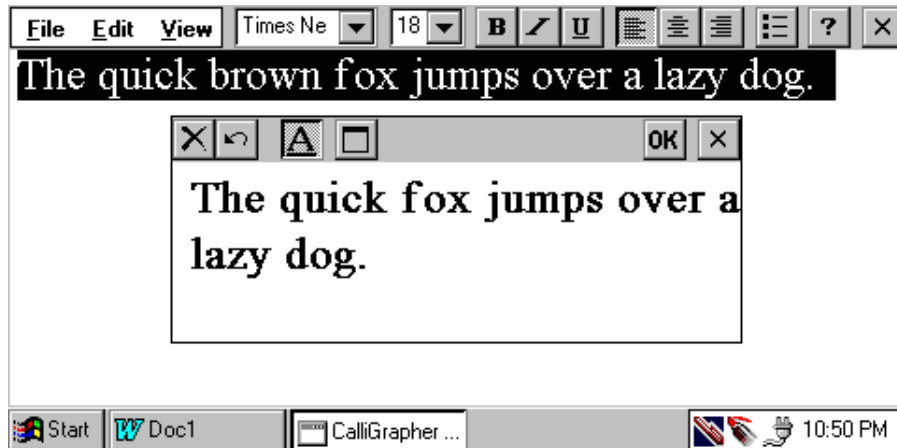

To capitalize a letter with a single gesture, start at the base of the letter you want to change and write a vertical line upwards:

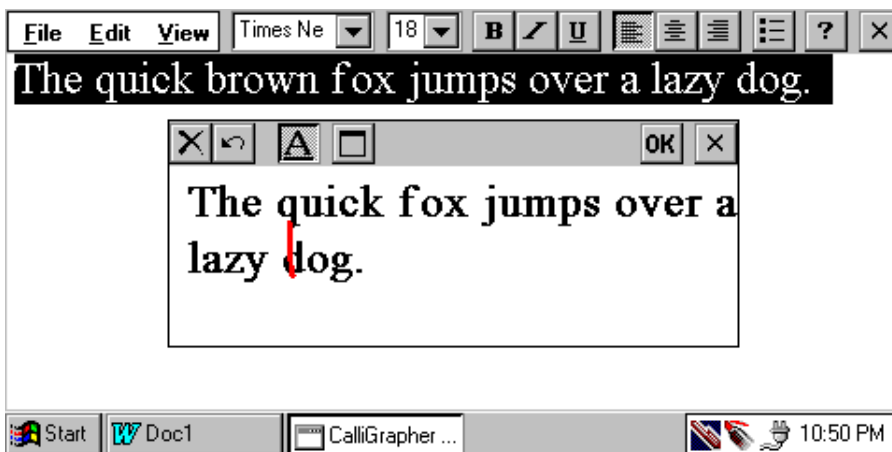

The result:

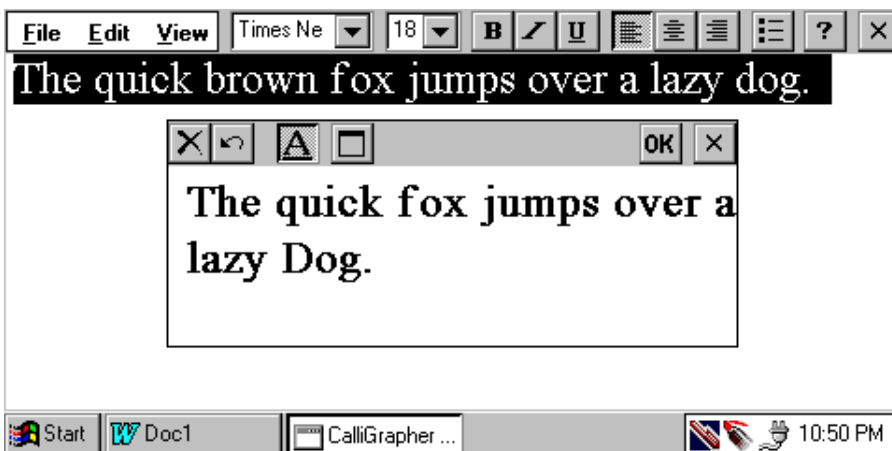

Close the Correction Window without accepting the edits by tapping the button with an "X" on it in the upper right of the window. It is to the right of the "OK" button.

Text Editing Using CalliGrapher

Up to this point, you have been editing through the correction window. You can also edit text directly within your document.

You can quickly erase text using the Erase gesture, which is one single horizontal line drawn from right to left. This gesture's effect is similar to that of the Back Space key.

If no text is selected in the window, the symbol or space immediately to the left of the cursor will be erased and the cursor will reposition itself one space to the left. In the following example several words are selected, and will be erased with the gesture.

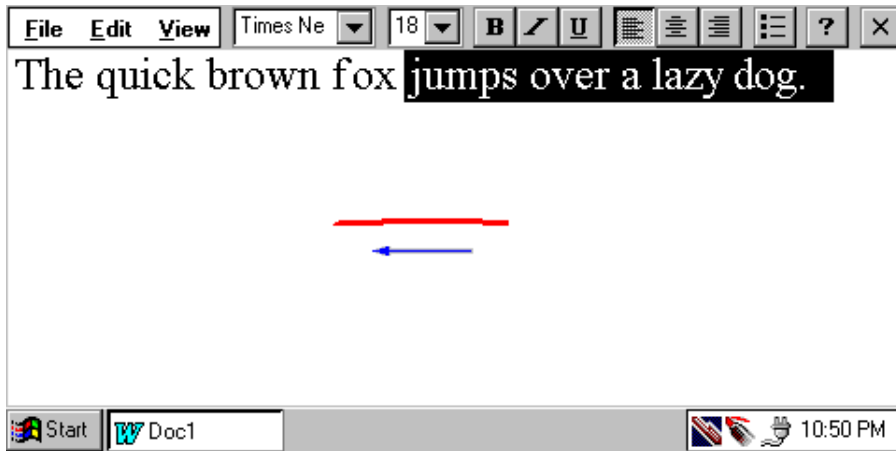

The selected text has been erased:

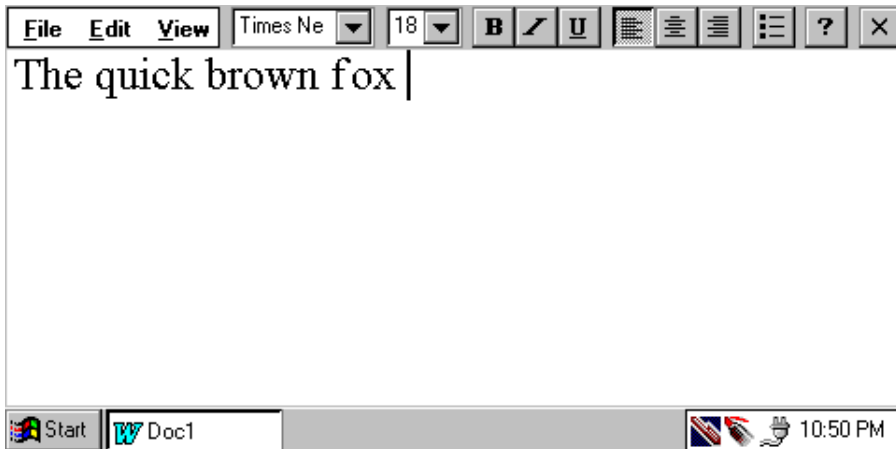

To insert a carriage return at the cursor position use the Carriage Return gesture, which resembles a reversed upper case "L". Be sure to extend the length of the base horizontal portion of the stroke to at least twice the down stroke portion.

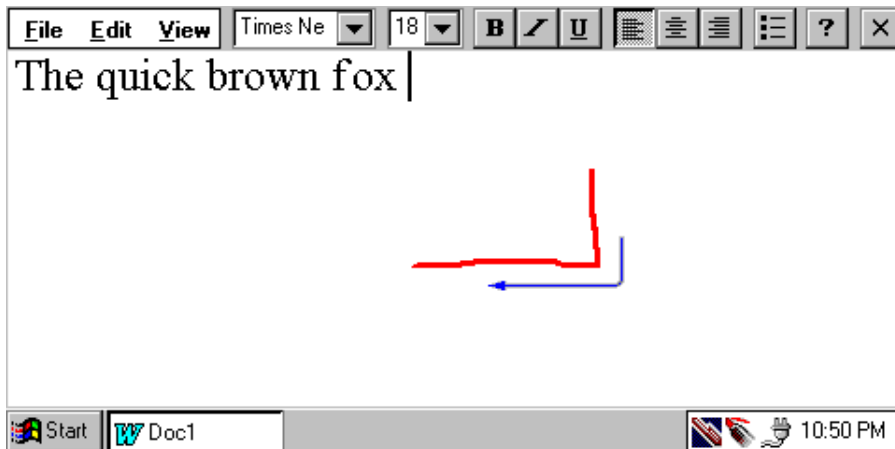

Note that the cursor has moved to the line below the text:

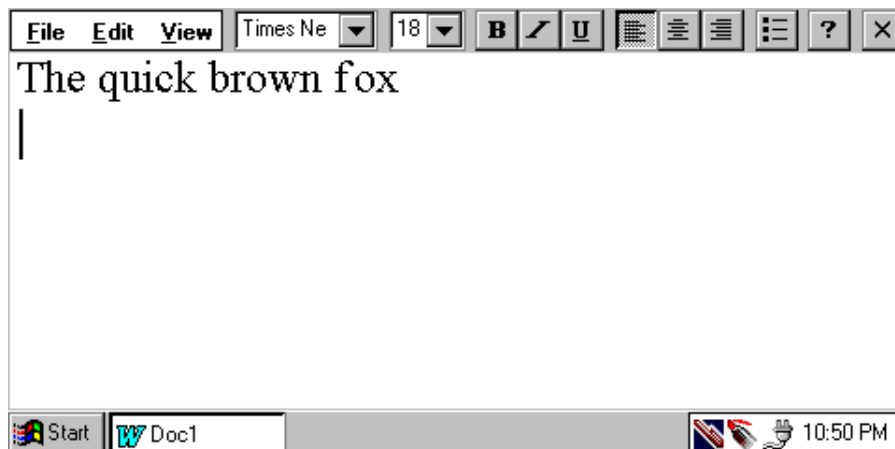

Now use the Erase gesture (horizontal line from right to left) to erase the carriage return and bring the cursor back to the end of the phrase.

Tap on the word "brown" between the "r" and the "o". The cursor will move between the letters. Use the Insert Space gesture to insert a blank space at the cursor position:

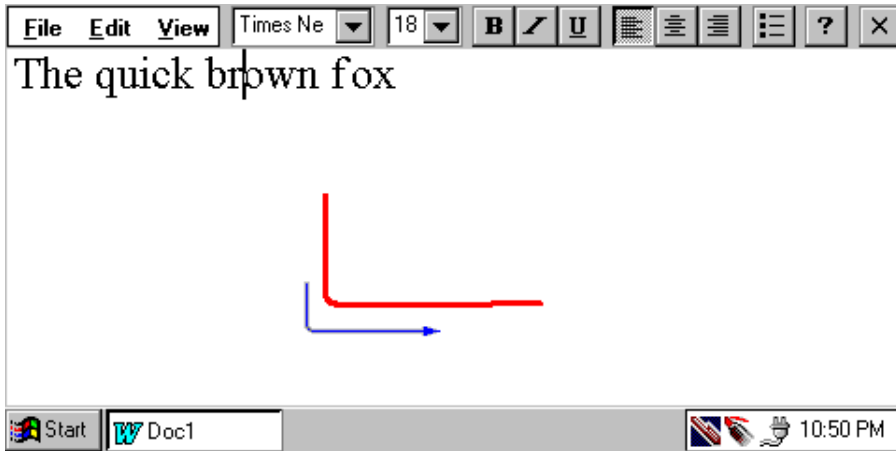

The space is inserted:

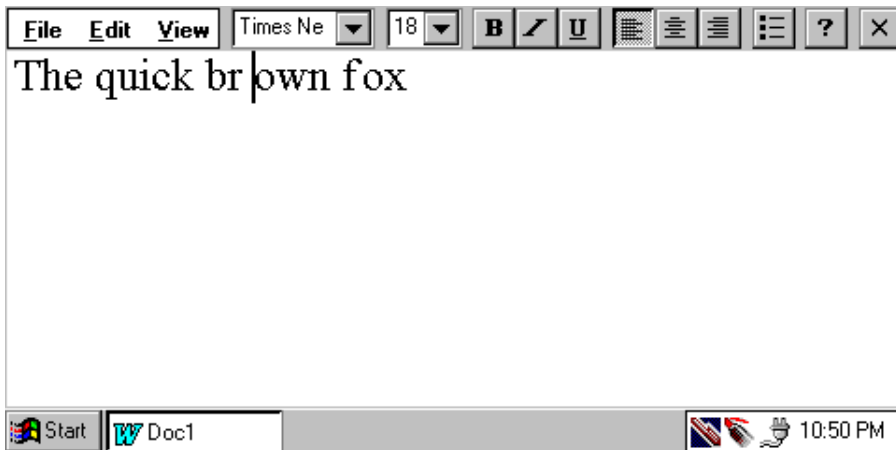

Use the Erase gesture again to remove the unneeded space. As you have learned earlier you can change the case of letters in the Correction Window by using the Case Changing gesture. It is simply an upward vertical stroke while the letter is selected. The same gesture can be used to similarly edit text in any window. First select the characters (individual letters, whole words or groups of words). Use the Case Changing gesture to change the case of the selection:

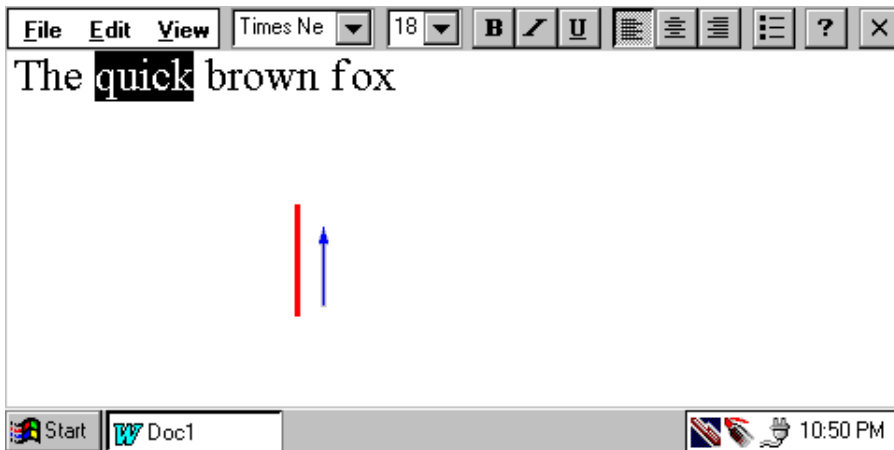

And the word "quick" becomes "QUICK":

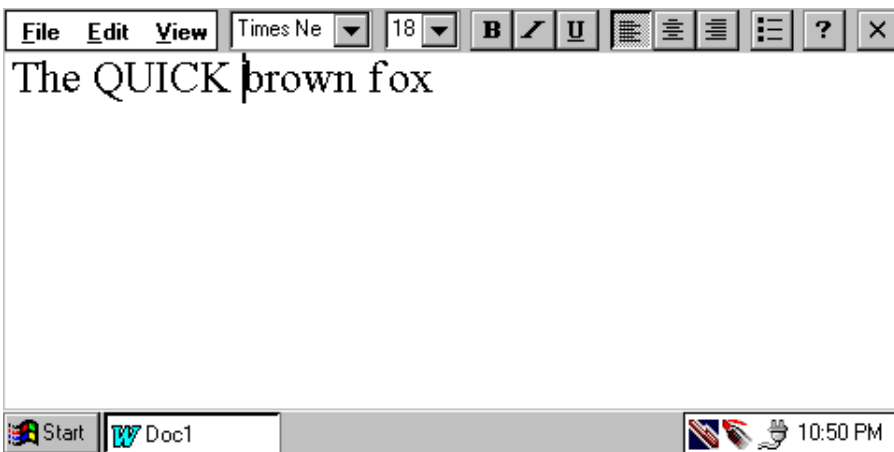

To reverse the action just completed use the Undo gesture to return the text to lower case (this is identical to pressing the Alt and Z keys on the keyboard). Note that the two 'legs' of the gesture have the same length:

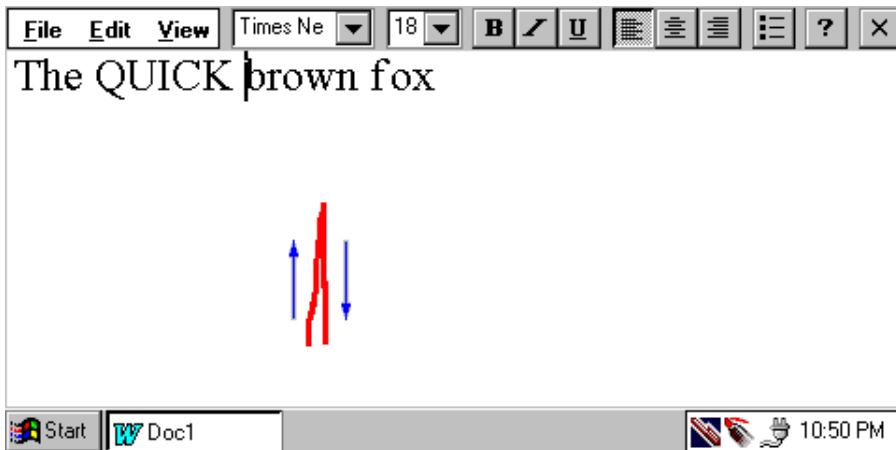

The text reverts to lower case:

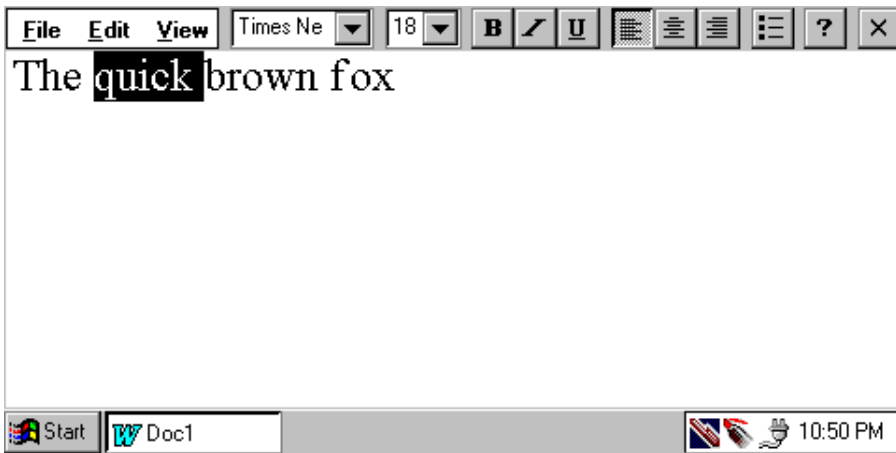

You may use your stylus to change letters and words. For example, to change the first letter in the word "brown" to "c", select the letter you wish to change, then simply write the substitute letter:

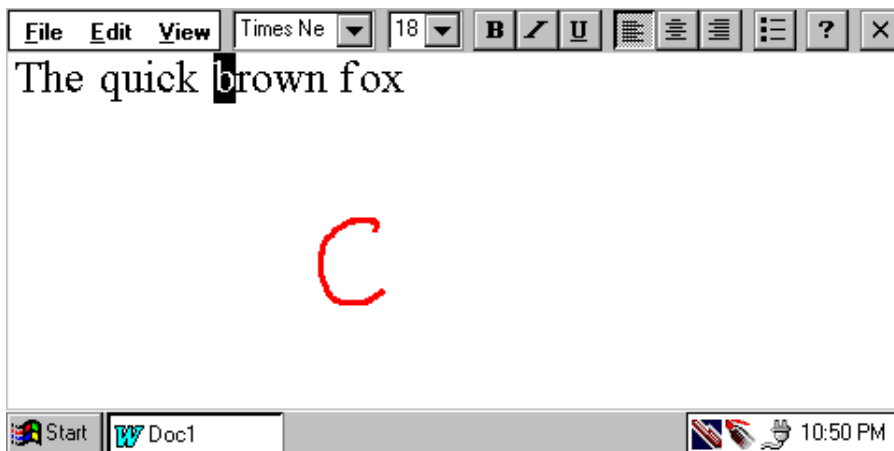

The recognized letter "c" replaces the selected "b":

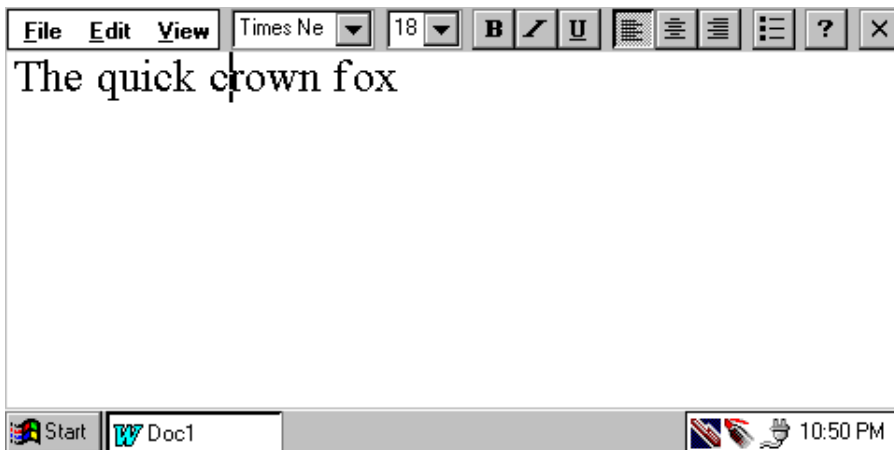

You can select and overwrite an entire word. For example, the word "quick" can be changed to "red":

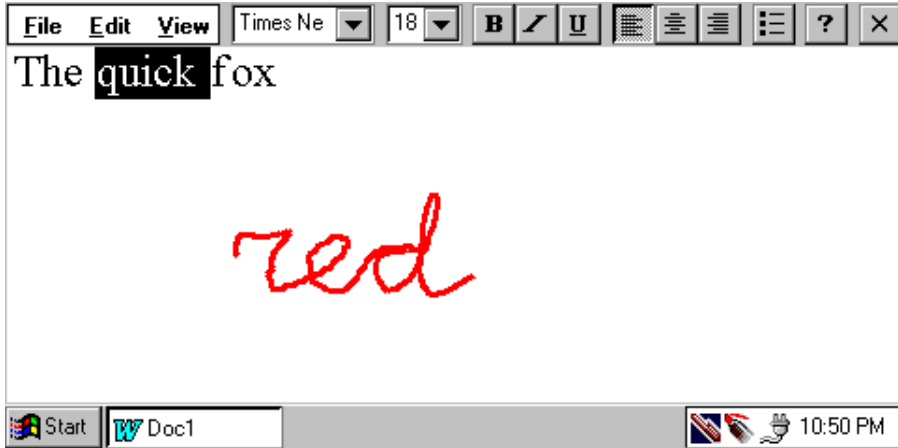

Here is the resulting word substitution:

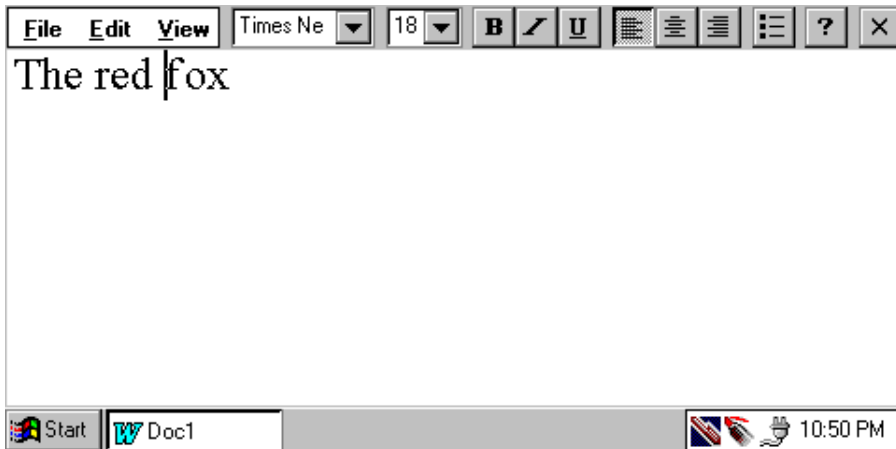

You can see these and other gestures in the CalliGrapher Help:



How to Select Text Using Pen (Stylus)

You can select text with your pen just as you would in the standard mode by pressing on your system display with the stylus and waiting for a "click" sound. With the stylus still pressed to the screen, drag it across the text you wish to select. Lifting the stylus ends the selection, leaving the text highlighted and ready for editing.

If you proceed with dragging the stylus before the "click" occurs, you can prevent CalliGrapher from interpreting this as a gesture or handwritten entry by maintaining the stylus position against the screen (do not lift up). Eventually CalliGrapher will "click" and select the text along the line you have drawn.

There is another method of selection. You can use it when all you need is to select a single word, or a few words on a single line. Just draw a horizontal line from left to right covering the words you wish to select. It works the same way as in the appropriate correction window example.

Screen Drawing

In CalliGrapher, you can not only write on the screen your text notes, but you can just draw on the screen, too. And your drawings can be saved for future use.

You may use this feature, for example, to show someone how one can get to your office:

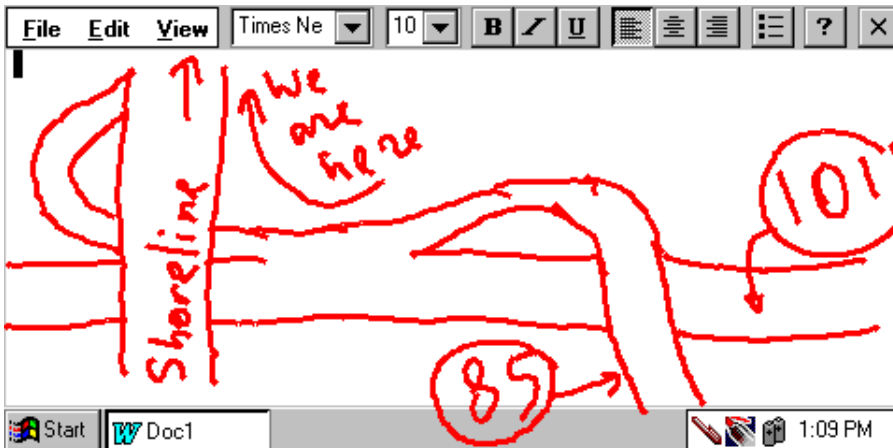

Or you may wish to jot down some ideas that came to your mind during lunch (so as not to forget them afterwards):

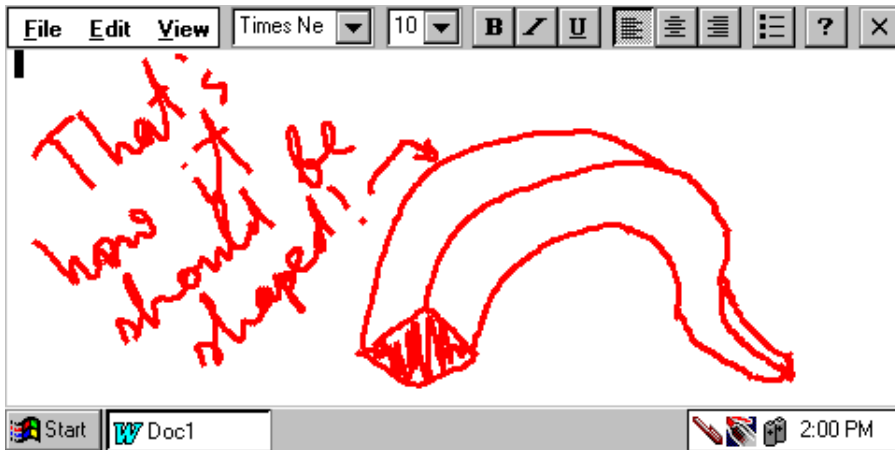

To use this feature, switch CalliGrapher to the ScreenDraw mode. This may be done either by selecting "ScreenDraw mode" from the CalliGrapher menu or by tapping on the marker icon on a taskbar so that it becomes highlighted, like this:



Now you can draw on top of everything that is on the screen.

Open CalliGrapher menu (as usual, by letting the pen tip rest for a while on any of the CalliGrapher icons in the tray). As you see, it is somewhat different from the Recognition mode menu:

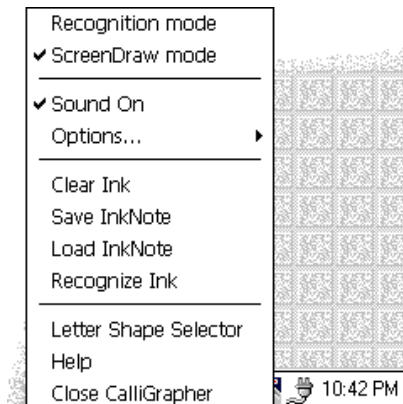

The new menu items are more or less self-explanatory - you can clear everything you've drawn, save or load your drawing, or force CalliGrapher to recognize your drawing as a handwritten text.

You can delete separate strokes in your drawing as well. Just cross the unwanted strokes with a new one and don't lift the pen until the "click" sounds - the crossed out strokes will be deleted.

Screen Orientation

With CalliGrapher, you can choose the orientation of the handwritten text. This way you can turn your PenCentra 200 upside down or sideways.

To change the orientation, you need to have the "Orientation" icon in the tray. Open the CalliGrapher menu. Select "Options...". Press on the "Icons" tab in the "CalliGrapher Options" dialog box. Make sure the "Orientation" option is checked, like this:



If it is not checked, tap on the check box below the arrow.

Press "OK" to close the "CalliGrapher Options" dialog box.

Now you should see the "Orientation" icon on a taskbar. It looks like an arrow pointing to the "up" direction for writing:



To change the writing orientation, tap on this arrow.

You may set orientation to 45 and 90 degrees directions. Tap on the arrow a few times to see what is available.

Calculator

CalliGrapher's RiteCalc feature makes it easy to perform simple mathematical operations just by writing a formula, such as $23*7.5=$ or $3.23+2.57=$.

Calculations are performed on numbers with up to two digits after the decimal point and seven digits before it. The result is limited to the same range. Allowed operations symbols are +, -, ×, *, ÷, :, /, %.

The command to perform a calculation is the equal sign (=) at the end of the formula. A formula (including the final "=") must be written as one sentence.

Configuration Tips

This section contains some additional things you may do with CalliGrapher using its various configuration settings.

To see and/or set the CalliGrapher configuration settings, open the CalliGrapher menu and choose "Options..." in it.

The options dialog will show up:

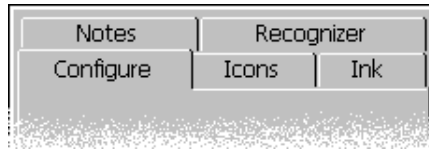

Now you are ready to follow the discussions in this part of Quick Start Guide.

Multiple User Dictionaries

When you add words to dictionary (using the local menu in the correction window), they go to your current User Dictionary.

You may have more than one user dictionary. For example, you could produce one user dictionary for special terms of your profession - to write technical notes, another one - for chess or bridge terms - to make notes during play, etc.

You may set the current user dictionary (or disable any) in the "Configure" tab in the options dialog.

Taskbar Customization

You may speed up some actions in CalliGrapher by putting the buttons for them on a Windows CE taskbar.

For example, if writing the correction gesture creates some difficulties for you, you may use the taskbar button for this purpose.

Conversely, if you always use CalliGrapher in one and the same mode and feel confident using gestures for editing, you may wish to unclutter the taskbar. In this case, remove the unwanted buttons/icons from it.

You may use the "Icons" tab in the options dialog to do the job.

More Pleasant vs. More Detailed Inking

The "Ink" tab in the options dialog allows you to set the width and the color of the ink. The ink trajectory looks most pleasing to eyes when it's width is set to 2 or 3 pixels. This is why 3 pixels is used as a default width.

You may wish, however, to see the fine details in the ink. In this case, set the ink width to 1.

Conversely, for the big display with fine resolution you may choose to increase ink visibility by increasing it's width.

If You Aren't a Cursive Writer...

If you never actually write cursive, you may prevent CalliGrapher from trying to interpret your letters as cursively written words. This should increase both recognition accuracy and the speed.

The appropriate control may be found in the "Recognizer" tab in the options dialog. It is called "Separate Letters Mode".

Quick Note Taking

With the CalliGrapher screen drawing, you can actually use your PenCentra 200 as a substitute of those small yellow sticky pieces of paper that get lost so easily.

You may configure the "Icons" and "Notes" options so that you'd be able to save your note (a.k.a. screen drawing) and clear the screen for the next one simply by a click of a button.

First, in "Icons" tab of the options dialog, make sure the "Save ScreenDraw Ink" action is checked:



Second, check the option "Save without prompt" in the "Notes" tab in the options dialog box:

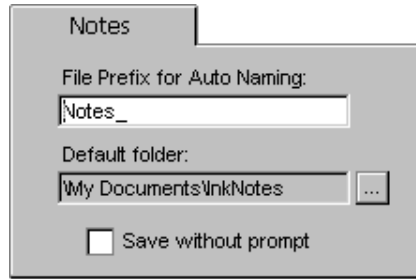

A button looking like a small diskette appears on the taskbar:



In the Screen Draw mode, write the note (like "Jim's phone - 111-22-33"). Tap on the diskette button, and your note will be saved and the screen cleaned for the next one!

The note will be saved as a file in the "Default folder"; the file name will be "File Prefix for Auto Naming" plus the time stamp (both are the options in the "Notes" tab in the options dialog box (shown above)).

Fine-tuning the Handwriting Features

Look at this word:

Fine

Can you tell whether the first letter is the capital "F" or the small "f"?

The problem is, some people write both letters like this and differentiate them only by their size (and in our example, the size is ambiguous). Other people write only the capital "F" this way, and for them this example should read "F", not "f", regardless of the actual letter size.

You may instruct CalliGrapher about what is your way of writing. If, for example, you only write the capital "F" like this, it wouldn't be recognized as "f".

To do this, open the CalliGrapher menu and select "Letter Shape Selector". You will see then something like this:

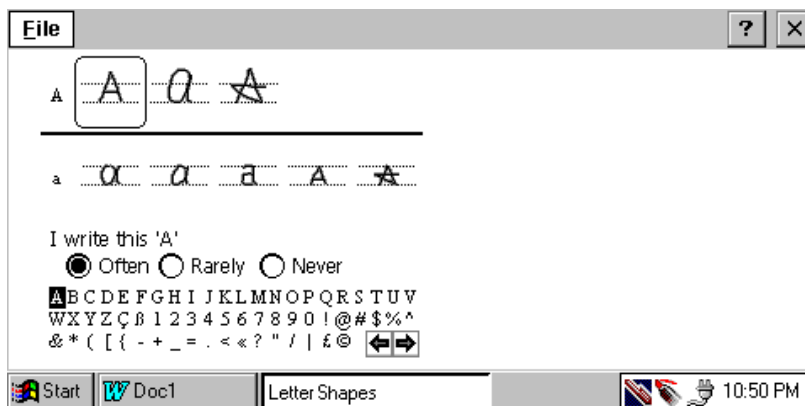

Here CalliGrapher shows you many common ways of writing characters. And you may tell it which of those you never use, or use rarely.

Tap on various parts of this display to see the effect. Don't worry: if you occasionally mess up the settings, you may always select "File / Use Original Settings" from the menu in the top left corner of the application window.

Tap on the currently selected letter shape (the one surrounded by the rounded rectangle). You will see the dynamics of that character writing.

The last note: there are two sets of letter shapes' settings, called Master and Guest. You may, for example, customize the "Master" set for yourself, the "Guest" set for someone who borrows your PenCentra 200 for a while. The currently used set is selected from the menu in the top left corner of the application window.

Using Handwriter for HPC 2000

The H/PC 2000 systems include two handwriting recognizers from CIC: Jot and Handwriter for HPC 2000. Jot offers single character recognition, providing immediate user feedback. Handwriter provides full context natural character recognition with complete macro and gesture support.

The Handwriter for HPC 2000 application provides tutorials for learning each of the utilities. Going through the tutorial exercises is strongly recommended in order to become comfortable with Handwriter for HPC 2000.

To access Handwriter, click on the Start button, then select Setting > Control Panel. Double-click on the Recognizer icon. The Recognizer Properties window consists of five tabs:

General tab

The General tab allows you to select the type of character set you would like the system to recognize. Select one of the three radio buttons:

- Jot - Character set that uses natural character shapes.
- Jot - Simplified uppercase characters
- Handwriter - Full character set

If you have selected either of the Jot buttons, the Tutorial button is available on the General tabs screen. Click on the Tutorial button to learn more about Jot and for an animated demo of the characters.

Appearance tab

The Appearance tab lets you customize the appearance of the on-screen “ink” created by choosing a line width and color.

You can also change the position and orientation of the mode mark in this window. The mode mark is a triangular shape that appears on the top or right edge of the screen when the recognizer software is active. When you write to the left (or bottom) of the mode mark, the characters appear as lowercase. When you write to the right (or top) of the mode mark, the characters appear as numbers. When you write in the center of the screen, straddling the mode mark, the characters appear as capitalized letters.

On the Appearance tab window, you can change the size and orientation of the mode mark, and determine whether you want it to be visible.

Note that when Handwriter is selected, the mode mark options are not available. This is because Handwriter recognizes all characters as written. For example, if a lowercase “e” is written, a lower-case “e” will appear. If an upper-case “E” is written, an upper-case “E” will appear. To “train” Handwriter to recognize your writing style, click on the HRS Advanced tab, and select the Trainer.

Time-Outs tab

When one of the Jot buttons is selected, the Time-outs tab allows you to determine two speeds:

- How long you must hold down the pen to switch from inking to text selection or drag-and-drop.
- How long you have to write the next stroke of a multi-stroke character.

If Handwriter is selected, the following two choices are available:

- How long you wish to allow before recognition occurs after you finish writing.
- How long before the pen switches from ink to text selection or drag-and-drop.

Advanced tab

The Advanced tab provides you with three buttons:

- Macro Editor: The Macro Editor lets you create shortcuts for phrases and actions.
- Trainer: If “Jot - Character set that uses natural character shapes” is selected in the General window, the Trainer allows you to customize the Natural Character Set by enabling or disabling character shapes. If “Jot - Simplified uppercase characters” is selected, the Trainer is disabled. If Handwriter is selected, the Trainer allows you to customize the full character set.
- Reset: The Rest button returns the settings of the Appearance and Time-out tabs to their default settings.

The Advanced tab for Handwriter additionally allows you to enable or disable the Recognition Dictionary, and to automatically insert a space after a pause when writing complete words.

About tab

The About tab provides version, copyright and patent information about Handwriter for HPC 2000.

Chapter 5

Care and Maintenance of the PenCentra 200

This chapter provides pointers on how to care for and maintain your PenCentra 200 pen tablet.

Protecting the Display Screen

The PenCentra 200 pen tablet is designed to provide you with years of service. Using a screen protector will help ensure that the screen remains as clear as possible. When installed, the screen protector becomes a durable, replaceable, antiglare writing surface that protects the display screen from abrasion.

To obtain additional screen protectors use Fujitsu part number FMWSP6 (12-pack) when ordering. Additional information about installation is included with the screen protectors.

Caution

During normal use of the pen tablet, small particles from the environment can become embedded in the pen tip and scratch the screen. To prevent scratching the screen, ensure that a screen protector is installed before using your pen tablet. The warranty does not cover a screen that is scratched as a result of not using a screen protector.

Installing a Screen Protector

To install a new screen protector on your pen tablet:

1. If a screen protector is already installed on the display screen, remove it before installing the new screen protector. The screen protector is held onto the display screen surface by a thin strip of adhesive around the edges. A notch in one corner of the screen protector allows you to slide your fingernail under the screen protector for easy removal.
2. Clean the adhesive residue from the screen surface by gently wiping the residue using a soft cotton cloth dampened with denatured alcohol. Ensure that all film has been removed from the screen before applying a new screen protector.

Cautions

- Cleaning the screen surface with denatured alcohol may result in streaking. If streaking occurs, buff the screen surface lightly with a soft, dry cloth.
- The PenCentra 200 pen tablet is **not waterproof**. Do not pour liquids on the system or wash it with a soaked cloth.

3. Remove the protective coating from the adhesive side of the new screen protector first.
4. Apply the screen protector to the display screen surface. When doing so, orient the screen protector with the adhesive side of the screen protector facing the display screen and the notched corner of the screen protector toward the lower left corner of the display screen.
5. Remove the protective plastic cover from the face of the screen protector.
6. Apply pressure to the screen protector with your finger using a continuous wiping motion along the edges. The adhesive sets completely within 48 hours. To ensure a good seal between the screen protector and the display, do not lift the screen protector from the display once it has been applied.
7. Clean any residue left behind by the protective coating from the exposed surface of the screen protector by wiping gently with a soft cotton cloth dampened with denatured alcohol. Wipe the screen protector with a soft dry cloth to remove any low-tack adhesive; this will help to prevent the pen tip from squeaking.

The screen protector is now installed.

Storing the PenCentra 200

Store the PenCentra 200 pen tablet in Suspended state with a fully charged battery pack installed. The PenCentra 200 battery pack always provides power to some system components, even when the system is in the Suspended state. If you plan to store the system with the battery pack removed, be sure to save any active data prior to storing; failure to do so could result in lost data.

Protecting the PenCentra 200 Pen Tablet in Harsh Environments

The PenCentra 200 pen tablet is designed for use in environments where there is no direct exposure to rain, mist, sprays, dirt, or other abrasive particles. The optional PenCentra 200 harsh environment case (FMWCC36) and the PenCentra 200 screen protector (FMWSP6) provide some protection in these environments, as well as from physical damage due to shock or vibration.

Note that the harsh environment case does *not* render the pen tablet waterproof, dustproof, or submersible.

The pen tablet is easily used while installed in the harsh environment case. For additional information on the PenCentra 200 harsh environment case as well as additional carrying cases and holsters, contact your reseller.

Avoiding Overheating

Excessive heat can damage internal components of the pen tablet over a period of time. To avoid overheating your PenCentra 200, do not charge the pen tablet while it is in the harsh environment case unless the system is either suspended or off.

Cleaning the Display Screen

To clean the pen tablet display screen, wipe the screen surface gently using a soft cotton cloth slightly dampened with water or denatured alcohol. Using denatured alcohol may result in streaking. If this occurs, gently buff the surface with a soft, dry cloth.

Caution

The PenCentra 200 pen tablet is not waterproof. Do not pour liquids on the pen tablet or wash the pen tablet with a heavily soaked cloth.

Troubleshooting the PenCentra 200

Solutions to some common problems are described in the following sections. If you are experiencing a problem with your PenCentra 200 pen tablet that you cannot solve by taking the actions described, contact your local help desk or your reseller for further assistance. If you need troubleshooting information for Windows CE Services, click **Windows CE Services Help Topics** on the **Help** menu in the Mobile Devices folder.

System Will Not Resume Operation

If the system will not resume operation after system operation has been suspended, the battery pack may either be discharged to a critically low level or there is the much less likely possibility that the battery pack is defective. To correct this problem, either connect an external power supply (such as the AC adapter), or install a charged battery pack in the pen tablet.

Display Screen Is Blank or Difficult to Read

If the display screen on your PenCentra 200 pen tablet appears blank or is unreadable, check the following:

- The backlight time-out may have expired. Tap on the display screen to reactivate the display. Note that this is a normal, power-saving feature.
- The system brightness may be set too low, causing the screen to appear too dark. Use the backlight brightness hotpad to adjust the screen brightness.
- The display contrast settings may be set to extreme high or low level causing the screen to appear blank. Try adjusting the contrast setting using the hotpads. Note that the ambient temperature will affect the display contrast. You may need to adjust the contrast periodically to compensate for changes in temperature.
- If the device doesn't respond when you briefly press the suspend/resume button, try holding the button down for a full second.
- Make sure your battery cover is locked.

Infrared Data Transfer Is Not Working

If you are experiencing problems transferring data between Windows CE-based devices, note the following:

- Transfer only one file, or no more than 25 contact cards at a time. For more information on contact cards, reference the section of Chapter 3 entitled “Contacts: Tracking Friends and Colleagues”.
- Can the IrDA port on the pen tablet “see” the IrDA port on the other device? A direct line-of-sight path must exist between the IrDA port on the pen tablet and the IrDA port on the other device.
- The distance between the two devices must be less than 3 feet (1 meter), but more than two inches.
- The viewing angle from the IrDA port on the pen tablet must not be more than 15 degrees from a center line between the IrDA port on the pen tablet and the IrDA port on the other device.
- Adjust the room lighting. Some types of light interfere with infrared communication (including direct sunlight). Try moving to a different location or turning off some lights.

Pen Tablet Is Not Responding to the Pen

If your pen tablet is not responding to the pen, check the following:

Note: *A quick way to tell if the pen is responding is to try to adjust the volume hotpad. You will hear a beep if it is working properly. This will help determine if the system is not responding or if the application is locked up.*

- Ensure that the pen tip is clean. Replace the pen if it is damaged.
- If available, connect a USB-style mouse to the system to see if it responds to click commands. If the system doesn’t respond to the mouse, the application or system may have crashed, and it may be necessary to reset the system.

Pen Tablet is Not Responding to the Keyboard

If the pen tablet is not responding to the keyboard, check the following:

- Make sure that you suspend and then resume the system before attempting to use the keyboard, otherwise it may not be recognized.
- Be sure that you are using a 5V keyboard.

Pen Not Calibrated

If the pen appears to be selecting an area of the screen other than the location at which you tap, you should calibrate the pen. See “Calibrating the Pen” in Chapter 2 for details.

Audio Volume Too Low

If the audio volume on your pen tablet speaker or external headphones is too low, check the following:

- Ensure that the volume level set with the Volume hotpads is set to an audible level. There are four different levels at which the Volume hotpad can be set. Tap it a few times to see if there is an increase in volume.
- Ensure that the volume level in the Control Panel/Volume and Sounds properties window are set to the maximum levels.

Remote connection problems

This section covers situations you may encounter when trying to connect your PenCentra to other sources of information. For problems with communicating with your desktop, see Windows CE Services Help.

Can't dial out with the device modem

- If using a PC Card modem, verify that the modem is firmly seated and connected to your PenCentra and the telephone jack.
- Make sure the telephone line is analog. (Analog telephone lines transmit data in analog instead of digital form. Your home telephone line is most likely analog, while office telephone lines are often digital.)
- Make sure you've correctly set dialing properties for this connection.
- Make sure the modem is waiting for a dial tone. Select **Start, Programs, Communication**, and then **Remote Networking**. Tap or click your connection once to select it, and then select **Properties** on the **File** menu. In the **Dial-Up Connection** dialog box, select the **Configure** button and then select the **Call Options** tab. Select **Wait for dial tone before dialing**.
- For international calls, allow more time for the call to go through. On the **Call Options** tab described in the previous bullet, clear the **Cancel the call if not connected within** option or increase the number of seconds allowed.

Can dial out but can't make a proper connection

- Make sure the network to which you are trying to connect supports Point-to-Point Protocol (PPP). PPTP connections are not currently supported. Your Internet service provider or network administrator can verify this.
- Verify that the location is correct. Select **Start, Settings, Control Panel**, and then double-tap or double-click the **Dialing** icon. Make sure that the location settings reflect your current location, that the location's dialing pattern is appropriate, and that the local country and area code are correct.

The connection is unreliable

- If using a PC Card modem, make sure the modem is firmly seated and connected to your PenCentra and the telephone jack.
- Disable call waiting. Select **Start, Settings, Control Panel**, and then double-tap or double-click the **Dialing** icon. Select **Disable call waiting by dialing** and enter the disable code specified by your telephone company.

Network connection is not listed in the ActiveSync dialog box

- Close the dialog box, wait a few minutes, and try again.

Appendix A

PenCentra 200 H/PC Pro Hardware Specifications

The following table provides general hardware specifications of the PenCentra 200 H/PC Pro by category.

PenCentra 200 Specifications	
Physical Specifications	
Dimensions	8.9" x 6.5" x 1.3" (226mm x 165.5mm x 33.6mm)
Weight	2 lbs. with battery (.91 kg)
Processing Specifications	
CPU	Toshiba TX3922
Processor Speed	129 MHz
Memory / Storage Specifications	
Main RAM	32 MB on main board (64 MB maximum)
Masked ROM	24 MB
Flash ROM (non-volatile storage)	16 MB
Input/Output Specifications	
Display	<ul style="list-style-type: none">Indoor/Outdoor Color Display 8" VGA (640 x 480), 256 colors Color-reflective DSTN with frontlightIndoor-Only Color Display 8" VGA (640 x 480), 256 colors Color transmissive DSTN with backlight
Digitizer	<ul style="list-style-type: none">Resistive, 10-bit resolution touchscreenOne-million-character durability rating

PenCentra 200 Specifications (Continued)

Backlight Control	Color Reflective Display (indoor/outdoor): Low-Medium-High-Off (via hotpad) Color Transmissive Display (indoor only): Very Low-Low-Medium-High (via hotpad) The backlight control defaults to last setting used.
VGA Controller	16-bit with hardware acceleration
VRAM	1 MB SDRAM
Interface Specifications	
PC Card Slots	<ul style="list-style-type: none"> • Two Type-II • PCMCIA version 2.1 • 5 V/3.3 V, 500 mA maximum power • “Radio Ready” for WAN PC Card radios
Modem	<ul style="list-style-type: none"> • The internal modems on all Fujitsu pen tablets from Fujitsu PC Corporation are only qualified for use with telephone systems in selected countries, including the United States and Canada. For a full list of certified countries, check www.fujitsupc.com/modems. • RJ-11 jack on top of system • Ring wakeup (internal or PC Card modem)
Integrated Interfaces	<ul style="list-style-type: none"> • USB-Host (Type-A connector) 5 V, 500 mA maximum current • PS/2-style keyboard (full-size, 6-pin DIN connector) 5 V, 500 mA maximum current • RS-232C serial port (full-size DB-9 connector) Note that Pin 9 on this serial port has 5 V, 500 mA maximum current support; Pin 9 on the optional docking station serial port does not support 5 V. • RJ-11 modem jack • DC Power
Infrared	IrDA version 1.1 (FIR, 4 Mbps)

PenCentra 200 Specifications (Continued)	
Audio	<ul style="list-style-type: none"> • PCM voice recording and playback (half-duplex) • Internal microphone and speaker • Microphone and headphone jacks (3.5 mm)
High-Usage Docking Contacts	<ul style="list-style-type: none"> • USB-Host (5 V, 500 mA maximum current) • RS-232C serial Note that Pin 9 on this serial port does not support 5 V current. • PS/2-style keyboard (5 V, 500 mA maximum current) • DC-in
User Controls	<ul style="list-style-type: none"> • Hotpads: Brightness, contrast, volume, right mouse, programmable (3) • Suspend/Resume (on/off) button • Record button • Reset button • Notification button
Status Indicators (LEDs)	<ul style="list-style-type: none"> • Notification • Charging • Low battery

PenCentra 200 Specifications (Continued)

Power Specifications

Main Battery	<ul style="list-style-type: none">• Removable, lithium ion• 10.8 V @ 1300 mAh• Dimensions: 6.3" x 1.0" x 0.5"• Weight: 5.25 oz. (150 g)• Warm-swappable• Recharge time: 90 minutes (90%), 180 minutes (100%)• Life: Approximately 8 hours operation, depending on backlight and application usage• Suspend Life: 20 days with a fully charged main battery.
Backup Battery	<ul style="list-style-type: none">• Internal NiMH, 3.6 V @ 70 mAh• Charge time: 90% - 2 days, 100% - 4 days• Automatically recharges from main battery when the system is on.• Suspend life (fully charged backup battery, dead main battery): 1.5 days
<h3>Additional Specifications</h3>	
Reliability	<ul style="list-style-type: none">• 50,000 hours MTBF• Heavy-duty Lexan housing with rubber handgrips• Breakaway serial port door hinges
Security Features	<ul style="list-style-type: none">• Kensington lock slot• Owner password capability

Digitizer Technology Notice

Additional Display Information

The display for your pen tablet incorporates a breakthrough digitizer technology that dramatically improves outdoor viewability. Compared to traditional outdoor displays, the new display excels in providing superior visibility in full sunlight, and a clear, bright picture indoors, in low light conditions, or at night.

This new technology involves the use of a liquid between the digitizer layers to minimize light refraction and reduce glare. As a result of this technology, users may notice the appearance of tiny air bubbles which are caused by changes in pressure (such as that experienced in an airplane). These tiny bubbles are temporary and do not affect system performance or usability. The digitizer functions normally when the air bubbles are present.

The air bubbles are formed when the liquid vaporizes due to pressure change. When the pen tablet is returned to normal use conditions, the tiny air bubbles are absorbed back into the liquid after a short amount of time.

If these air bubbles are visually distracting, or if they form a larger bubble, gently rub the screen with a soft cotton cloth in a circular motion, similar to cleaning the screen of fingerprint oil.

Glossary

AC adapter

An adapter that provides external power (not battery power) to your PenCentra 200 H/PC.

ActiveSync

A component of Windows CE Services that manages data synchronization between your PenCentra 200 and desktop computer when you are working remotely. You can specify the type of data you want to synchronize.

Application Manager

The Windows CE Services feature that enables you to add and remove software on your PenCentra 200. In the Mobile Devices window, click Tools and then click Application Manager.

appointment

An entry in Calendar.

attachment

An item included with an e-mail message.

backup file

A duplicate copy of the program data on your PenCentra 200. This file does not include settings and information stored in ROM, such as factory-installed software. Use your backup file to return your PenCentra 200 to its previous state if your system data is damaged or destroyed, or if you have performed a full reset.

baud rate

The speed at which a modem transmits data. This is set at 19200 Kb/sec by default on your PenCentra 200.

calibrate

The process that determines how the stylus and touch screen interact. You can calibrate both the screen alignment and the stylus double-tap settings.

COM port

See *communications port*.

command bar

The combination toolbar and menu bar used in Windows CE.

communications port

A serial communications port used to connect equipment, such as mobile devices, modems, and printers.

connection

The ability to interact with another device, computer, or the Internet by means of a serial, infrared, Ethernet, or dial-up connection.

data

Information that is stored in any of your Windows CE program files.

desktop computer

A computer running Microsoft Windows 95/98 or Windows NT to which you connect your PenCentra 200.

dial-up connection

A connection between your PenCentra 200 and a remote computer by means of a modem. You can connect to an ISP, a network, or a modem attached to a PC.

direct connection

A connection between your PenCentra 200 and another computer by means of a serial cable or infrared ports.

download

The process of transferring data from your desktop computer to your PenCentra 200.

e-mail

Messages and other items that you send and receive with Inbox.

Explorer window

The window that appears when you double-click a device icon in the Mobile Devices window. In the Explorer window, which is part of Windows CE Services, you can view and copy files between your PenCentra 200 and your desktop computer.

file conversion

The process of converting Windows-compatible files on your desktop computer to Windows CE-compatible files on your PenCentra 200, and vice versa.

FPC

Fujitsu PC Corporation (www.fpsi.fujitsu.com).

full reset

See *reset*.

HEC

An optional Harsh Environment Case, used to provide extra protection for your PenCentra 200.

IMAP4

(Internet Message Access Protocol) An e-mail protocol supported by some mail servers. When using IMAP4, the folders you create on your desktop computer or PenCentra 200 are mirrored on the mail server so that the contents of the folders are available from any computer with access to your mail server.

Inbox synchronization

A feature in Windows CE Services that enables you to synchronize mail between your PenCentra 200 and desktop computer. Your computer must be on and running Microsoft Exchange 5.5 or Outlook 97/98.

Inbox Transfer

A feature in Microsoft Outlook and Microsoft Exchange that enables you to transfer specific e-mail messages between your PenCentra 200 and desktop computer.

Internet connection

A communications method used to establish a link between your PenCentra 200 and a server that provides access to the Internet, typically, an ISP.

Internet service provider (ISP)

A company that provides access to the Internet.

intranet

A network designed for information sharing within a company or organization.

IrDA (infrared) connection

A connection between your PenCentra 200 and another computer or device (such as a printer) by means of the IR port on each device.

local folder

A folder that is available only from the location in which it was created. In POP3, any folder you create on your PenCentra 200 is a local folder, and any messages it contains can only be viewed from the PenCentra 200.

message header

A line of summary information, such as sender and subject, for an e-mail message.

mobile device

A computer that runs Microsoft Windows CE.

Mobile Devices folder

The folder on the desktop computer that contains the Windows CE Services components.

modem card

See *PC Card*.

My Documents folder

The folder that stores files you create on your PenCentra 200. You can view the contents of this folder in the Explorer window in Windows CE Services.

network connection

A connection between your PenCentra 200 and a network by means of an Ethernet card inserted into your PenCentra 200.

OEM

Original equipment manufacturer. The OEM for the PenCentra 200 is FPC.

offline folder

When using IMAP4, a folder that contains messages that are available when working online or offline.

partnership

The process of establishing a connection between your desktop computer and your PenCentra 200 for the purpose of synchronizing and transferring data. Your PenCentra 200 can have partnerships with up to two desktop computers.

PC Card

A removable card, such as modem, Ethernet, or storage card, that conforms to the PCMCIA specification.

PC Link

The program on your PenCentra 200 that you use to connect and synchronize with your desktop computer when using a serial cable or IR.

POP3

(Post Office Protocol) An e-mail protocol supported by most mail servers.

port settings

The settings used to configure a communications port on a computer.

PPP

(Point-to-Point Protocol) The protocol that your PenCentra 200 uses to communicate with your Internet service provider's network server.

RAM

Random Access Memory

ROM

Read-only Memory

RAS (Remote Access Service) account

A network account that enables your PenCentra 200 to remotely access your corporate network.

remote connection

A connection between your PenCentra 200 and a remote computer. You make a remote connection by using a modem or an Ethernet card.

Remote Networking

The Windows CE folder where you establish a dial-up connection between a mobile device and a remote computer.

reset

Depending on the state of your PenCentra 200, a process that either causes the system to reboot or erases all data stored in RAM.

restore

To return your PenCentra 200 to the state it was in when it was backed up. This involves copying your backup data to your PenCentra 200.

serial cable

A cable to connect your PenCentra 200 to your desktop computer.

serial connection

A connection between your PenCentra 200 and a desktop computer or external modem by means of a serial cable.

slider

The vertical double bar on the command bar used to switch between displaying toolbar buttons and menu names.

stylus

A pointing device, similar to a pen, used to make selections (tap) and enter information on the touch screen.

synchronization

The process of comparing the data on your PenCentra 200 with the corresponding data on your desktop computer and updating either computer with the most up-to-date data.

synchronization service

A service in Windows CE Services that allows for synchronization of specific items between the PenCentra 200 and desktop computer. You can synchronize appointments, contacts, tasks, e-mail messages, and files.

TCP/IP

(Transmission Control Protocol/Internet Protocol)

The protocol that your PenCentra 200 uses to communicate remotely.

toolbar

A bar at the top of the screen that contains buttons that perform specific tasks.

touch screen

A touch-sensitive screen on your PenCentra 200 that can recognize the location of a touch on its surface (typically done by using a stylus) and translate that touch into a desired action (such as making a selection or moving the cursor).

Windows CE Services

The desktop computer program used to synchronize, transfer, and manage data and files between your PenCentra 200 and desktop computer. You open Windows CE Services by double-clicking the Mobile Devices folder.

Appendix D

Agency Notices

FCC Notices

This equipment has been tested and found to comply with the limits for a Class B digital device, pursuant to Part 15 of the FCC rules.

Changes or modifications not expressly approved by Fujitsu PC Corporation, could void the user's authority to operate the equipment.

Notice to Users of Radios and Television

These limits are designed to provide reasonable protection against harmful interference in a residential installation. This equipment generates, uses, and can radiate radio frequency energy and, if not installed and used in accordance with the instructions, may cause harmful interference to radio communications. However, there is no guarantee that interference will not occur in a particular installation. If the equipment does cause harmful interference to radio or television reception, which can be determined by turning the equipment off and on, the user is encouraged to try to correct the interference by one or more of the following measures:

- Reorient or relocate the receiving antenna.
- Increase the separation between the equipment and receiver.
- Connect the equipment into an outlet that is on a different circuit than the receiver.
- Consult the dealer or an experienced radio/TV technician for help.

Shielded interconnect cables must be employed with this equipment to ensure compliance with the pertinent RF emissions limits governing this device.

Notice to Users of the US Telephone Network

Note: *All configurations of the PenCentra 200 do not have an internal modem. The following information applies only to those systems with an internal modem.*

The PenCentra 200 pen tablet is supplied with an internal modem which complies with Part 68 of the FCC rules. On the pen tablet is a label that contains the FCC Registration Number and Ringer Equivalence Number (REN) of this system, along

with other information. If requested, users must provide their telephone company with the following information:

- The telephone number to which the pen tablet is connected
- The Ringer Equivalence Number (REN) for this equipment
- The information that the system requires a standard modular jack type USOC RJ-11C which is FCC Part 68-compliant
- The FCC Registration Number

This equipment is designed to be connected to the telephone network or premises wiring using a standard modular jack type USOC RJ-11C which is FCC Part 68-compliant.

The REN is used to determine the number of devices you may connect to your telephone line and still have all those devices ring when your number is called. Too many devices on one line may result in failure to ring in response to an incoming call. In most, but not all, areas, the sum of all of the devices should not exceed five (5). To be certain of the number of devices you may connect to your line, as determined by the RENs, contact your local telephone company.

If this equipment causes harm to the telephone network, your telephone company may discontinue your service temporarily. If possible, they will notify you in advance. If advance notice is not practical, they will notify you as soon as possible. You will also be advised of your right to file a complaint with the FCC.

This fax modem also complies with fax branding requirements per FCC Part 68.

If you experience trouble with this equipment, please contact your support representative.

Your telephone company will probably ask you to disconnect this equipment from the telephone network until the problem is corrected and you are sure that the equipment is not malfunctioning.

This equipment may not be used on coin service telephones provided by your telephone company. Connection to party lines is subject to state tariffs. Contact your state's public utility commission, public services commission, or corporation commission for more information.

FCC rules prohibit the use of non-hearing aid compatible telephones in the following locations or applications:

- All public or semipublic coin-operated or credit card telephones.
- Elevators, highways, tunnels, (automobile, subway, railroad, or pedestrian) where a person with impaired hearing might be isolated in an emergency.
- Places where telephones are specifically installed to alert emergency authorities such as fire, police, or medical assistance personnel.
- Hospital rooms, residential health care facilities, convalescent homes, and prisons.
- Workstations for the hearing impaired.
- Hotel, motel, or apartment lobbies.
- Stores where telephones are used by patrons to order merchandise.
- Public transportation terminals where telephones are used to call taxis or to reserve lodging or rental cars.
- In hotel and motel rooms at least ten percent of the rooms must contain hearing aid compatible telephones which will be provided to hearing impaired customers on request.

DOC (Industry Canada) Compliance Notices

This digital apparatus does not exceed the Class B limits for radio noise emissions from digital apparatus as set forth in the radio interference regulations of the Canadian Department of Communications.

Le présent appareil numérique n'émet pas de bruits radioélectriques dépassant les limites applicables aux appareils numériques de classe B prescrites dans le règlement sur le brouillage radioélectrique édicté par le Ministère des Communications du Canada.

Notice to Users of Radios and Television

This Class B digital apparatus meets all requirements of the Canadian Interference-Causing Equipment regulations.

Cet appareil numérique de la classe B respecte toutes les exigences du règlement sur le matériel brouilleur du Canada.

Notice to Users of the Canadian Telephone Network

The Canadian Industry Canada label identifies certified equipment. This certification means that the equipment meets certain telecommunications network protective,

operational, and safety requirements. The Department does not guarantee the equipment will operate to the user's satisfaction.

Repairs to telecommunication equipment should be made by a Canadian authorized maintenance facility. Any repairs or alterations not expressly approved by Fujitsu Personal Systems, Inc. or any equipment failures may give the telecommunications company cause to request the user to disconnect the equipment from the telephone line.

The connecting arrangement code for this equipment is CA11A.

The Load Number is 0.2.

The Load Number assigned to each telephone terminal device denotes the percentage of the total load to be connected to a telephone loop or circuit to be used by the device to prevent overloading. The termination on a loop may consist of any combination of devices such that the total of the load numbers of all devices does not exceed 100.

Caution

For safety, users should ensure that the electrical ground of the power utility, the telephone lines, and the metallic water pipes are connected together. Users should **not** attempt to make such connections themselves but should contact the appropriate electric inspection authority or electrician. This may be particularly important in rural areas.

Avis Aux Utilisateurs Du Réseau Téléphonique Canadien

L'étiquette canadienne Industrie Canada identifie l'équipement certifié. Cette certification signifie que l'équipement satisfait certaines normes de protection, d'exploitation et de sécurité des réseaux de télécommunications. Le département ne garantit pas le fonctionnement de l'équipement à la satisfaction de l'utilisateur.

Le PenCentra 200 possède un modem interne conforme aux normes de certification d'Industrie Canada pour protéger les réseaux de télécommunications et satisfaire aux normes de sécurité. Avant de connecter cet équipement à une ligne téléphonique, l'utilisateur doit vérifier s'il est permis de connecter cet équipement aux installations de télécommunications locales. L'utilisateur est averti que même la conformité aux normes de certification ne peut dans certains cas empêcher la dégradation du service.

Les réparations de l'équipement de télécommunications doivent être effectuées par un service de maintenance agréé au Canada. Toute réparation ou modification, qui n'est pas expressément approuvée par Fujitsu Personal Systems, Inc., ou toute défaillance de l'équipement peut entraîner la compagnie de télécommunications à exiger que l'utilisateur déconnecte l'équipement de la ligne téléphonique.

Le code d'arrangement de connexion de cet équipement est CA11A.

Le numéro de charge est 0.2.

Le numéro de charge assigné à chaque terminal téléphonique indique le pourcentage de la charge totale pouvant être connecté à une boucle ou à un circuit téléphonique, utilisé par ce périphérique afin de prévenir toute surcharge. La terminaison d'une boucle peut être constituée de n'importe quelle combinaison de périphériques de sorte que le total de numéros de charge de tous les périphériques n'excède pas 100.

Avertissement

Pour assurer la sécurité, les utilisateurs doivent vérifier que la prise de terre du service d'électricité, les lignes téléphoniques et les conduites d'eau métalliques sont connectées ensemble. Les utilisateurs NE doivent PAS tenter d'établir ces connexions eux-mêmes, mais doivent contacter les services d'inspection d'installations électriques appropriés ou un électricien. Ceci peut être particulièrement important en régions rurales.

Index

A

- ActiveSync, 48, 53
 - downloading messages, 48
 - managing messages, 49
- Agency Notices
 - DOC (Industry Canada) Compliance Notices, 111
 - FCC Notices, 109
- auto adapter, 2

B

- battery
 - charging, 21
 - removing and installing, 20
- battery charger, 2
- battery lock, 10
- battery pack
 - storing in system unit, 90
- battery pack latch, 5

C

- Calendar, 38
- calibrating the pen, 17
- CalliGrapher, 12, 59
 - basic writing and corrections, 63
 - configuration tips, 83
 - correction window, 67
 - fine-tuning the handwriting features, 85
 - gestures and spell checking, 67
 - getting started, 60
 - icons, 61
 - multiple user dictionaries, 83
 - quick note taking, 84
 - screen drawing, 80
 - screen orientation, 82
 - selecting text with a pen, 80
 - taskbar customization, 83
 - text editing, 72
- Calligrapher
 - calculator, 82

- CE Services, 56
- cleaning the display screen, 91
- connecting remotely
 - getting help, 55
- connecting to an ISP, 51
- connecting to the network, 52
- connectors and peripheral interfaces, 8
- Contacts, 41
- creating a dial-up connection, 52
- creating a dial-up connection to a modem, 55
- creating an Ethernet connection, 52

D

- dc input, 9
- DC input connector, 5
- display
 - screen is blank, 93
 - screen, cleaning, 91
- docking station, 2

E

- email, 44
 - sending a message, 49

F

- file conversion, 57
- folding deskstand, 2

G

- getting connected remotely, 50
- Glossary, 103

H

- handstrap, 2
- handstrap attachment points, 5
- Handwriter for HPC 2000, 87
- handwriting recognition applications, 12, 59

- handwriting recognition utilities, 59
- harsh environment case, 2, 91
- headphone jack, 5, 9
- high-usage contacts, 9
- high-usage docking contacts, 5
- hotpads, 3
 - backlight brightness, 23
 - contrast, 23
 - programmable, 1, 2, 3, 24
 - right mouse button, 23
 - volume, 23

I

- Inbox, 44
 - connecting to a mail server, 45
 - disconnecting from server, 46
 - downloading messages, 46
 - managing messages, 46
 - sending and receiving email, 44
 - setting up, 45
- infrared data transfer not working, 94
- InkWriter, 34
 - creating notes and drawings, 36
- inserting/removing PC Cards, 19
- installing a screen protector, 89
- IrDA port, 3, 8
- ISP
 - creating a dial-up connection, 51

J

- Jot, 87

K

- Kensington Lock, 3, 8

M

- microphone, 3
- microphone jack, 5, 8
- Microsoft Pocket Office, 25
 - opening, 25
- mobile keyboard, 2
- modem jack, 3, 9

N

- notification button, 3, 8

O

- overheating, avoiding, 91

P

- PC Card doors, 3
- PC Cards, 8
 - inserting and removing, 19
- pen
 - not responding, 94
 - replacing, 18
- pen holder, 3
- Pen Not Calibrated, 95
- pen tether, 2, 5
- PenCentra 200
 - care and maintenance, 89
 - cleaning the screen, 91
 - hardware specifications, 97
 - items included with, 1
 - options available, 2
 - overheating, 91
 - powering, 20
 - protecting, 91
 - protecting in harsh environment, 91
 - resetting the system, 16
 - setting up, 15
 - storing, 90
 - troubleshooting, 93
 - turning the system off and on, 15
- PenCentra 200 H/PC Pro Hardware Specifications, 97
- Pocket Access, 30
 - creating a new database, 31
- Pocket Excel, 28
- Pocket Outlook, 37
 - Calendar, 38
 - Contacts, 41
 - Inbox, 44
 - Tasks, 42
- Pocket PowerPoint, 32
 - showing a presentation, 32
- Pocket Word, 26
 - entering text, 26

- normal view, 26
- outline view, 26
- portfolio, 2
- powering the PenCentra 200, 20
- protecting the display screen, 89
- protecting the PenCentra 200 in harsh environments, 91
- protecting the screen, 89
- PS/2-style port, 5, 9

R

- RAM expansion module, 2
- RAM/ROM door, 5
- record button, 3, 8
- remote networking, 50
- remote synchronization, 58
- removeable battery pack, 5
- reset button, 3
- resetting the system, 16
- resuming system operation, 93
- ROM expansion module, 2

S

- screen, 3
- screen protector
 - installing, 89
- screen protectors, 2
- sending a message, 49
- serial port, 5, 9
- slip case, 2
- spare battery, 2
- spare pen, 2
- speaker, 5, 10
- status indicators, 3, 7
 - battery, 7
 - DC input, 7
 - notification indicator, 7
- Stylistic LT C-500 Specifications
 - input/output, 101
 - memory/storage, 101
 - physical, 101
 - processing, 101

- suspend/resume button, 3, 9, 15
- synchronizing files, 57
- synchronizing remotely, 53
- system holster, 2
- system will not resume operation, 93

T

- Tasks, 42
- troubleshooting
 - audio volume too low, 95
 - can't dial out with modem, 95
 - can't make proper connection, 95
 - connection is unreliable, 96
 - connection not listed in ActiveSync dialog box, 96
 - cursor not tracking pen, 94
 - infrared transfer not working, 94
 - no response to pen, 94
 - remote connection problems, 95
 - screen is difficult to read or blank, 93
 - system will not resume, 93

U

- USB port, 5, 9
- Using the Pen, 17

V

- Voice Recorder, 34
 - recording and playing, 35

W

- where to find information, ix
- Windows CE
 - applications, 25
- Windows CE Services, 56
 - installing, 56
 - remote synchronization, 58
 - setting up a partnership, 56
 - synchronizing files, 57
- Windows CE website, x

